

Knight Piésold (Pty) Ltd



CONCEPTUAL DESIGN OF STORMWATER MANAGEMENT, SEWAGE INFRASTRUCTURE AND ACCESS ROADS BETWEEN BOILER EDGE SLAB AND ROAD NO.3 (RING ROAD WEST) AND DESIGN OF THE NEW GYPSUM OFFTAKE INFRASTRUCTURE SLAB, ASSOCIATED DRAINAGE, AND ACCESS ROADS

ESKOM HOLDINGS SOC LIMITED

PREPARED BY:

Knight Piésold (Pty) Ltd.
4 De la Rey Road
Johannesburg, Rivonia

tel. 011 806 7111 • fax. 011 806 7100

Date: October 2017

Knight Piésold
CONSULTING

www.knightpiesold.com

ESKOM HOLDINGS SOC LIMITED

MEDUPI POWER STATION

**CONCEPTUAL DESIGN OF STORMWATER
MANAGEMENT, SEWAGE INFRASTRUCTURE AND ACCESS
ROADS BETWEEN BOILER EDGE SLAB AND ROAD NO.3
(RING ROAD WEST) AND DESIGN OF THE NEW GYPSUM
OFFTAKE INFRASTRUCTURE SLAB, ASSOCIATED
DRAINAGE, AND ACCESS ROADS**

OCTOBER 2017

Knight Piésold
CONSULTING



Knight Piésold (Pty) Limited
Consulting Engineers and Environmental Scientists
P O Box 221
RIVONIA
2128

Tel: +27 11 806 7111

Fax: +27 11 806 7100

e-mail: rivonia@knightpisold.com

Web: www.knightpiesold.com

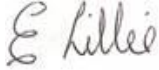
Report Issue	Final		
KP Reference	303-00828/01		
Eskom Reference	200-605353		
	Name	Signature	Date
Author	Eugeshin Naidoo Civil Engineer		October 2017
Document Reviewer	Edwin Lille, Pr.Eng. Senior Engineer		October 2017
Approved by	Edwin Lille, Pr.Eng. Senior Engineer		October 2017

List of Abbreviations

DEA	Department of Environmental Affairs
DWS	Department of Water and Sanitation
EAP	Environmental Assessment Practitioner
EIA	Environmental Impact Assessment
FGD	Flue Gas Desulphurisation
GPR	Ground Penetration Radar
HDPE	High Density PolyEthylene
NEMWA	National Environmental Management Waste Act
PVC-U	Unplasticized poly (Vinyl Chloride)
SANS	South African National Standards
WWTP	Waste Water Treatment Plant
ZLD	Zero Liquid Discharge
ZLED	Zero Liquid Effluent Discharge

Glossary

Pre-development	Refers to the current infrastructure development on site
Post-development	Refers to the proposed FGD infrastructure development on site

ESKOM HOLDINGS SOC LIMITED

MEDUPI POWER STATION

TASK ORDER NO.: 650

CONCEPTUAL DESIGN OF STORMWATER MANAGEMENT, SEWAGE INFRASTRUCTURE AND ACCESS ROADS BETWEEN BOILER EDGE SLAB AND ROAD NO.3 (RING ROAD WEST) AND DESIGN OF THE NEW GYPSUM OFFTAKE INFRASTRUCTURE SLAB, ASSOCIATED DRAINAGE, AND ACCESS ROADS

OCTOBER 2017

Table of Contents

1	Introduction	2
2	Scope of Work	3
3	Methodology	3
3.1	Project Initiation, Setup and Management	3
3.2	Site Visit	3
3.3	Stormwater Management Infrastructure	3
3.4	Sewage Infrastructure	5
3.5	Access Roads	6
3.6	Truck Loading Facility for Immediate Gypsum Offtake	6
4	Design Criterion	6
4.1	Stormwater management	6
4.2	Sewage Infrastructure	8
4.3	Access Roads and Truck Loading Facility for Immediate Gypsum Offtake	8
4.3.1	Geometric design	8
4.3.2	Pavement design	9
4.3.3	Traffic Management	9
4.3.4	Truck Loading Facility for Immediate Gypsum Offtake	9
5	Stormwater Management	9
5.1	Existing Stormwater management system	10
5.2	Pre-development and Post-Development Flows	15
5.2.1	Post-development flows Alternative 1	16
5.2.2	Post-development flows Alternative 2	17
5.3	Truck Loading Facility for Immediate Gypsum Offtake	24
5.4	Drainage Philosophy for the Oil Based Transformers Absorber Substations and FGD Common Substation	26
5.5	Sump Water Drainage	29
6	Sewage Infrastructure Design	32

6.1	Existing Sewer Reticulation Infrastructure	32
6.2	Pre-development and Post-Development Sewage Flows	33
6.2.1	Pre-development Sewage Flows	33
6.2.2	Post-development Sewage Flows	36
6.3	Sewage Drainage Design	36
7	Costs for the Proposed FGD Stormwater and Sewer Infrastructure	39
8	Water Balance	42
9	Truck Loading Facility Slab for Immediate Gypsum Offtake	46
9.1	Pavement Design- Structural Capacity Estimation	46
9.2	Liner Design for the Dirty Area	47
9.3	Service life considerations for HDPE Liner	49
9.4	Recommended Quality Control of the Liner system During Construction	49
9.5	Leakage through the Composite Liner System	50
10	Access Roads	51
10.1	Traffic Management Plan	51
10.2	Access Roads Design	51
10.2.1	Geometric design	52
10.2.2	Pavement design	56
10.3	Construction Cost Estimate	58
11	Conclusions	61
11.1	Stormwater Management	61
11.1.1	Alternative 1	61
11.1.2	Alternative 2	62
11.2	Sewage Infrastructure Design	63
11.3	Water Balance	63
11.4	Truck Loading Facility Slab for the Immediate Gypsum Offtake	63
11.4.1	Pavement Design- Structural Capacity Estimation	63
11.4.2	Liner Design for the Dirty Area	64
11.5	Access Roads Design	64
11.5.1	Traffic Management Plan	64
11.5.2	Access roads design	64
12	Recommendations	65
13	References	66

Tables:

Table 1: Stormwater design criteria 7
 Table 2: Sewage infrastructure design criteria..... 8
 Table 3: Pre-development catchment properties 11
 Table 4: Pre-development and Post Development Flood Peaks Alternative 1 18
 Table 5: Pre-development and Post Development Flood Peaks Alternative 2 19
 Table 6: Rational method inputs and results..... 25
 Table 7: Pipeline design checks..... 26
 Table 8: Calculated minimum bund height..... 28
 Table 9: Pipeline design checks..... 28
 Table 10: Gravity fed pipeline calculation results..... 31
 Table 11: Design criteria used in estimating hydraulic loads 34
 Table 12: Post-development peak flow rates 36
 Table 13: Pipeline design checks 38
 Table 14: Comparison of pre-development and post-development peak flows..... 38
 Table 15: Cost of stormwater and sewer infrastructure Alternative 1 Option 2 39
 Table 16: Cost of stormwater and sewer infrastructure Alternative 2 40
 Table 17: Monthly rainfall scenarios 43
 Table 18: Sewer water contributions to the Sewage Treatment Plant..... 46
 Table 19: Assumptions and results from the M10 pavement design method 47
 Table 20: Construction cost estimate..... 59

Figures:

Figure 1: Proposed Medupi FGD layout 10
 Figure 2: Layout and extent of the clean water system 12
 Figure 3: Layout and extent of the dirty water system 13
 Figure 4: Delineated pre-development clean and dirty water catchments for the Main FGD area..... 14
 Figure 5: Catchment 1 and 5 were re-designated to dirty water catchments (Alternative 1)..... 20
 Figure 6: Option 1- Tie in into existing dirty water system 21
 Figure 7: Option 2- New pipeline to the Dirty Water Dam..... 22
 Figure 8: Catchment designated remains the same as pre-development scenario (Alternative 2) 23
 Figure 9: Proposed layout of truck loading facility and associated stormwater management 25
 Figure 10: Layout plan showing the identified sump connection point for the FGD Common Pump Building 29
 Figure 11: Layout plan showing the identified sump connection point for the FGD Common Pump Building 30
 Figure 12: Existing sewer reticulation network..... 35
 Figure 13: Layout plan for sewage network for the FGD Make-up Water Pre-treatment Building 37
 Figure 14: Layout plan for sewage network for the FGD Common Pump Building and ZLD Building 37
 Figure 15: Clean surface water runoff contributions to the Clean Water dam 44
 Figure 16: The dirty surface water runoff contributions to the Dirty Water dam 45
 Figure 17: Class C Landfill Barrier System (DEA, 2013b) 49
 Figure 18: Design Vehicle WB-67D 52
 Figure 19: Design Vehicle WB-67D: possible vehicle turning movements 54
 Figure 20: Gypsum loading platform contour detail 56
 Figure 21: Proposed pavement structure..... 57
 Figure 22: Typical longitudinal and transverse joint layout plan 58

1 INTRODUCTION

The Medupi Power Station Flue Gas Desulfurization (FGD) Retrofit Project consists of the addition of FGD systems to six 800 megawatt (MW) coal fired steam electric generating units being constructed in Limpopo Province, approximately 15 kilometres (km) west of the town of Lephalale, South Africa. Medupi's Unit 6 entered commercial operation on 23rd August 2015. The FGD Project will result in the addition of wet limestone open spray tower FGD systems to each of the operating units and will be operational within six years following commercial operation of the respective generating units.

The Medupi plant is currently under construction. Each of these units has been designed and is being constructed with provisions incorporated into the space and equipment design to accommodate the installation of wet limestone FGD systems. Each of the six FGD absorbers will treat the flue gas from one boiler; commercial-grade saleable gypsum, chemical sludge and chemical solids will be produced as by-products. A cluster of three absorbers will be located near each of the plant's two chimneys. Systems for makeup water, limestone preparation, FGD by-product (gypsum) dewatering and storage/disposal, and treatment of the wastewater stream will be common to all FGD absorbers in the plant. (200-122784, Medupi FGD Retrofit Basic Design Report).

The FGD areas can be categorised into 2 areas, the limestone off-loading area and the main FGD area. The limestone off-loading area is the area designated for receiving limestone via the new Rail Siding or trucked via a new access road network. The main FGD area is the area on the western side of the existing Boilers, which comprises of the Process and proposed Waste Water Treatment Plants (WWTP). The limestone and gypsum conveyor servitudes connect the main FGD area and limestone off-loading area.

This design report is for the conceptual design of the new gypsum off-take infrastructure slab, stormwater management system, sewage system and access roads specifically between the Boiler edge slab and Road 3 (Ring Road West) in the main FGD area.

NOTE: The scope is based on utilising Wet Flue Gas Desulphurisation technology.

2 SCOPE OF WORK

The scope of work is to carry out conceptual level designs for the following proposed infrastructure in the main FGD area:

- Stormwater management system for the FGD impacted areas;
- Sewage drainage infrastructure;
- Access roads as identified on drawing (0.84/28836 Rev. 5.1, Medup1 FGD Retrofit Project, Site Arrangement);
- Gypsum off-take infrastructure (open facility with a concrete bunded slab, associated drainage and access road.)
- The conceptual designs will form part of the Environmental Impact Assessment (EIA) process.

3 METHODOLOGY

3.1 Project Initiation, Setup and Management

Project administration and progress reporting (weekly) were undertaken to ensure that the design meets with the overall project objectives.

3.2 Site Visit

A site visit by the senior design engineers was carried out (15th August 2017) to assess the site and familiarise themselves with site conditions. The site visit was used to gather data to proceed with the study and concept design.

3.3 Stormwater Management Infrastructure

Medupi Power Station has existing stormwater drainage designs for the area west of the boilers. With the introduction of the FGD Plant, new infrastructure is anticipated.

The conceptual designs included the stormwater management along the servitude that falls within the demarcated scope area i.e. From the boiler edge slab to Road No.3 (Ring Road West). This includes the conveyor servitudes positioned in this demarcated area.

The conceptual designs were developed in conjunction with the final terrace layout drawing for the specified area as shown in drawing 0.84/193, Medupi Power Station, Terrace Layout, Contour Plan and Setting Out.

The following activities were carried out for the general FGD stormwater design:

- The delineated catchments areas were classified as either clean or dirty. This was done with the consultation of site personnel and water quality results where available.
- All existing drainage infrastructure (within the area contributing to the drainage network) was identified using the existing station drawings provided.
- The pre-development stormwater flows (including any process flows contributing to the system) were calculated based on the delineated catchments within the impacted FGD areas. This was undertaken to determine the flows currently contributing to the stormwater drainage network.
- The post-development flows were calculated to determine the additional flows that will be entering the existing stormwater drainage network. These results were used to assess whether the existing stormwater drainage network has the capacity to accommodate the additional stormwater volumes. This ensured that the new stormwater management designs tie into the existing stormwater drainage network.
- The new stormwater drainage infrastructure was designed based on the post-development flood peaks. The new drainage structures were designed for the 1:50 year return period.
- The downstream clean and dirty water dams were assessed to verify that they are able to accommodate the additional flow requirements.

The following activities were carried out for the FGD process water drainage design:

- The conceptual design included the drainage philosophy for the oil based transformers attached to the exterior of the 6 x Absorber Substations and FGD Common Substation buildings. The current drainage philosophy at Medupi PS is to utilise an oil capture pit with a honey sucker removing the oil when required was maintained in the design.

The following activities were carried out for the sump water drainage:

- The conceptual designs included the identification of suitable existing drainage connection points in the vicinity of the Common Pump Building and Raw Water Pre-treatment building for the drainage of process water collected in these building sumps (0.84/ 37847, General Arrangement, FGD Common Pump Building and 0.84/ 36759, General Arrangement, FGD Makeup Water Pre-treatment Building). This included conceptually designing the pipes from the sumps to the selected drainage connection points. A maximum sump depth of 2m was taken into account also considering the terrace layout drawing for the ground levels. The designs ensured that the existing stormwater network and resulting dams can adequately cater for the additional flows.

3.4 Sewage Infrastructure

The Medupi Power Station consists of an existing sewage network which connects to an onsite Sewage Treatment Plant. The conceptual design involved the sewage drainage from the sources identified below. The design conveys sewage into the existing sewage network from the sources identified and then to the existing Sewage Treatment Plant at Medupi Power Station.

The following buildings required sewage drainage. These comprise of ablutions and safety showers.

- Common Pump Building, 1 x safety shower, Refer to drawing 0 84/ 37847, General Arrangement, FGD Common Pump Building;
- Raw Water Pre-Treatment Building, 1 x safety shower; 0 84/ 36759, General Arrangement, FGD Makeup Water Pre-treatment Building;
- Raw Water Pre-Treatment Area, 1 x safety shower, 0 84/ 36244, General Arrangement, FGD Makeup Water Pre-treatment Area;
- Proposed ZLD Building, 3 x safety showers and ablutions; 0 84/ 37689, General Arrangement, FGD ZLD Treatment Building.

The following activities were carried out:

- Identification of all existing sewer reticulation infrastructure including sumps within the area. This was done in accordance with the existing station drawings and aerial survey provided;

- Calculation of pre-development sewage flows and any other additional process flows which currently contribute to the existing sewage network;
- Calculation of post-development flows to determine the additional flow entering the existing sewage network;
- Assessment of the capacity of the existing sewage network to accommodate the additional flow entering the system,
- Assessment of the capacity of the existing Sewage Treatment Plant to accommodate the additional flow entering the system,

3.5 Access Roads

All roads identified as required on drawing 084/ 28836 (Medupi FGD Retrofit Project, Site arrangement) were designed. This was limited to the gypsum off-take access and loading platform. This was designed as a permanent access to the major FGD Infrastructure.

Storm water control measures were included in the roads design in order to prevent erosion of the wearing course. The stormwater management design was integrated with the access roads design, ensuring that slopes along the road and areas draining into the access roads are consistent and compatible with the clean and dirty water drainage points designed.

Where interfaces exist with the existing roads, the design allowed for a seamless tie in.

3.6 Truck Loading Facility for Immediate Gypsum Offtake

The conceptual designs include the gypsum off-take infrastructure to enable immediate truck off-take for saleability. The design comprised of an open facility with a concrete bunded slab, access roads and stormwater drainage from the facility.

4 DESIGN CRITERION

4.1 Stormwater management

The stormwater infrastructure design criteria are described below:

- The proposed stormwater design interfaces with all existing infrastructure on site. Levels and positioning were considered to ensure that no flooding occurs at any of the existing buildings. The natural ground levels were assessed in accordance with the latest aerial

survey provided (February 2017) and drawings 0.84/193, Medupi Power Station, Terrace Layout, Contour Plan and Setting Out .

- The clean-water and dirty-water drains were designed to carry the peak runoff rate from a 1:50 year recurrence interval storm from the clean and dirty areas.
- Stormwater conduit design criteria is shown below in Table 1:

Table 1: Stormwater design criteria

Mannings coefficient of friction (n)	0.012
Pipe/culvert material	Reinforced concrete (Bearing SANS Mark). Minimum pipe diameter of 450mm.
Pipe joint type	Spigot and socket (including rubber ring)
Pipe Class (all diameters)	A minimum class of 100D was assumed for all concrete stormwater pipes.
Culvert Class	Generally 100S (Loading conditions for each application to be confirmed)
Bedding type	Class varies between A, B and C (SANS 1200 LB)
Min. Slope	0.5%
Min. Slope 450mm dia. and larger	Min. velocity criteria applies
Max velocity	Design flow velocities are to be between 0.5m/s and 3.0m/s with the desirable minimum range of between 0.9m/s and 1.5m/s. The absolute minimum of half-full velocity is not less than 0.6m/s.
Min Cover (Trafficked Areas)	1400mm (below final road level)
Min Cover (Sidewalks)	1400mm (below final kerb level)
Min Cover (general)	1000mm
Max. distance between manholes	50m apart and at a minimum are located at the following: -Two or more storm drains converge; -Pipe sizes change; -Change in alignment occurs; -Where a change in grade occurs.

- The following regulations were considered:
 - GN704: National Water Act, 1998 (Act No. 36 of 1998) Regulations on use of water for mining and related activities aimed at the protection of water resources.
 - Liner Regulations: Liner containment barrier systems. National Environmental Management Act (Act 59 of 2008). NEMWA Regulations R634, R635 and R636.

4.2 Sewage Infrastructure

The design criteria for the sewage infrastructure will be obtained from the following Standards and Guidelines:

- SANS 10400 Part P – Drainage.
- Red Book Guidelines for Human Settlement Planning and design (CSIR. 2005);
- Manual on the Design of Small Sewage Works, (WRC, 2009).

The design criteria is summarised in Table 2 below:

Table 2: Sewage infrastructure design criteria

Mannings coefficient of friction (n)	0.009
Design Period	Typically 20 years for general sewers and 50 years for sewer outfalls
Pipe	PVC-U Heavy Duty Class 34 HPDE sewer pipes for all sizes above 400mm
Min. Slope	0.4% (1:250)
Min. Slope 450mm dia. and larger	Min. velocity criteria applies
Max velocity	Design flow velocities in gravity sewers are to be between 0.7m/s and 2.0m/s.
Min Cover (Trafficked Areas)	1400mm (below final road level)
Min Cover (Sidewalks)	1400mm (below final kerb level)
Min Cover (general)	1000mm
Max. distance between manholes	SANS 2001-DP4 50m apart and at a minimum are located at the following: -Two or more storm drains converge; -Pipe sizes change; -Change in alignment occurs; -Where a change in grade occurs.

4.3 Access Roads and Truck Loading Facility for Immediate Gypsum Offtake

4.3.1 Geometric design

The retrofit of gypsum off-take loading platform follows the same design approach applied for the original terrace roads. The geometric design standard complies with the requirements of *UTG10: Guidelines for the Geometric Design of Commercial and Industrial streets*. The road layouts/configuration are in accordance with Eskom's requirements.

4.3.2 Pavement design

Considering the envisaged local road building materials available and expected traffic, the recommended pavement structure for the internal roads is a concrete base and stabilised subbase configuration.

The pavement design is based on a combination and design comparison of the TRH 4 Catalogue design guidelines and a mechanistic design in order to meet the requirement for an E2 Class road that is both suitable for medium volume traffic and heavy loading.

4.3.3 Traffic Management

A logistics/ transportation study has been carried out taking into consideration the expected traffic, traffic loading and frequency, whilst conforming to the requirements set out in the Terms of Reference. Traffic Management is attached under separate cover in Appendix C.

4.3.4 Truck Loading Facility for Immediate Gypsum Offtake

All concrete structures are designed in accordance with the following codes of practice and criteria as applicable:

- TMH 7: 1981, Parts 1, 2 & 3 Code of practice for the design of highway bridges and culverts in South Africa.
- South African Pavement Engineering Manual, Chapter 10 Pavement Design. (SANRAL, 2014).
- SABS1083: 1994, Aggregates from natural resources: aggregates for concrete.

5 STORMWATER MANAGEMENT

The conceptual designs included the stormwater management along the servitude that falls within the demarcated scope area (highlighted in red in Figure 1) i.e. From the boiler edge slab to Road No.3 (Ring Road West).

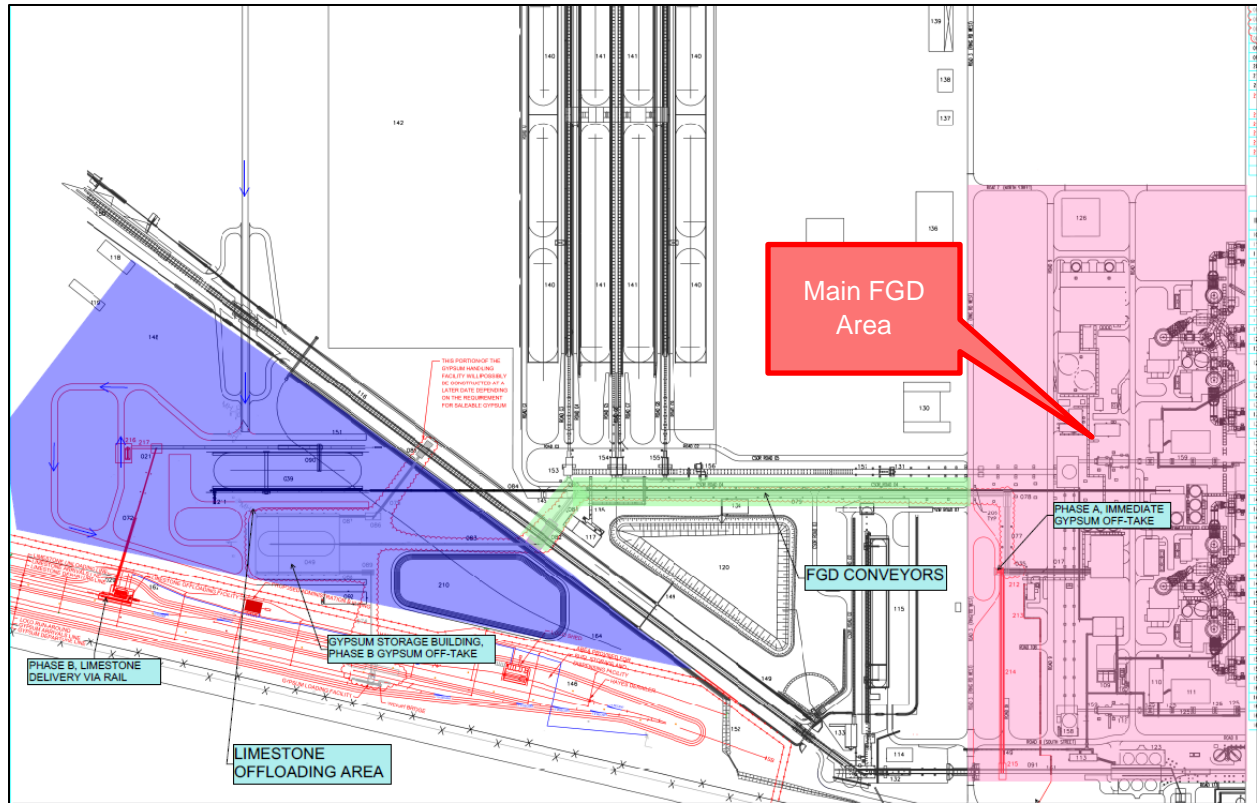

Figure 1: Proposed Medupi FGD layout

5.1 Existing Stormwater management system

The clean-water and dirty-water drains within the terrace area were designed (using the Witwat Stormwater Drainage Program) to convey the peak runoff rate from a 1:50 year recurrence interval storm (24 hour duration). The underground drains were designed to be pre-cast concrete culverts of various sizes. The layout and extent of the clean water system is shown in Figure 2, the system drains into the Clean Water Dam. The layout and extent of the dirty water system is shown in Figure 3, the system drains into the Dirty Water Dam. The main FGD area was originally designed using the clean-dirty water catchment designation shown in Figure 4; Table 3 describes the characteristic of these catchments. The system was designed based on future anticipated land use, i.e. the percentage of impervious area per catchment was based on future development of catchments. This level of development will be classified as the pre-development scenario.

Based on these delineated catchments the volume of runoff calculated for the 1:50 year recurrence interval 24 hour duration storm is 40700 m³ for the Dirty Water Dam and 55000 m³ for the Clean Water Dam. These volumes are required to be stored over and above the minimum water level in the dam and the operational requirements of the Power Station for the respective dams. The total storage capacity is 102 000 m³ for the Dirty Water Dam and 133 400 m³ for the Clean Water Dam.

Table 3: Pre-development catchment properties

Catchment	Clean/ Dirty	Area (ha)	Flow Length (m)	% Impervious	Slope (m/m)	Pipeline Diameter (m)	Q _{Pre-dev} (m ³ /s)
1	Clean	4.81	300	60	0.005	0.9	1.24
5	Clean	3.99	300	60	0.005	1.05	1.028
4	Clean	2.44	300	70	0.005	0.675	0.672
8	Clean	2.4	300	70	0.005	0.9	0.661
60	Dirty	2.1	200	80	0.005	0.75	0.727
61	Dirty	2.1	200	80	0.005	0.9	0.727
6	Clean	0.88	160	50	0.005	1.35	0.276
9	Clean	0.88	160	50	0.005	1.05	0.276
50	Dirty	5.06	200	90	0.005	1.2	1.848
51	Dirty	5.06	200	90	0.005	1.05	1.848
52	Dirty	5.06	200	90	0.005	1.35	1.848

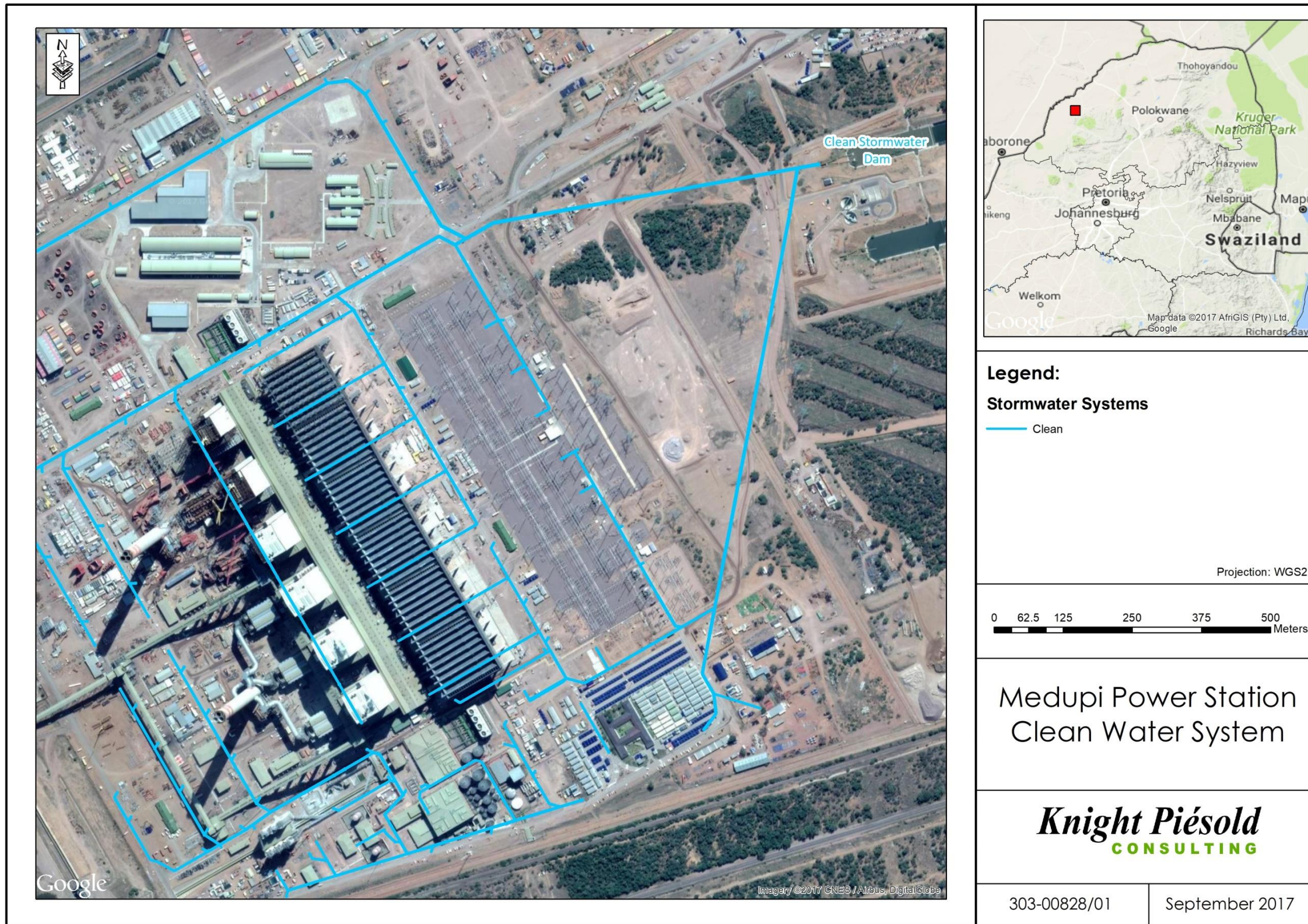

Figure 2: Layout and extent of the clean water system

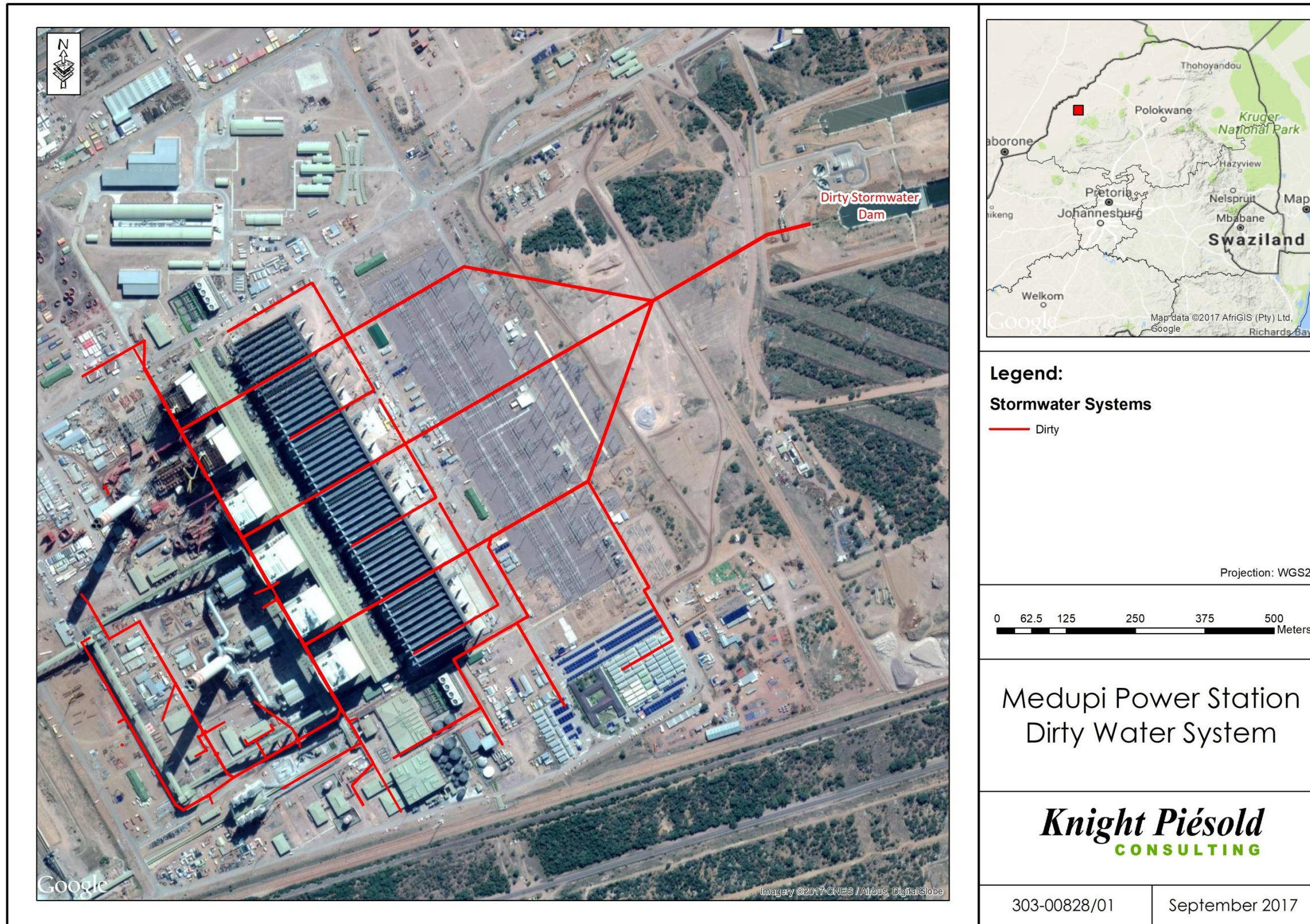

Figure 3: Layout and extent of the dirty water system

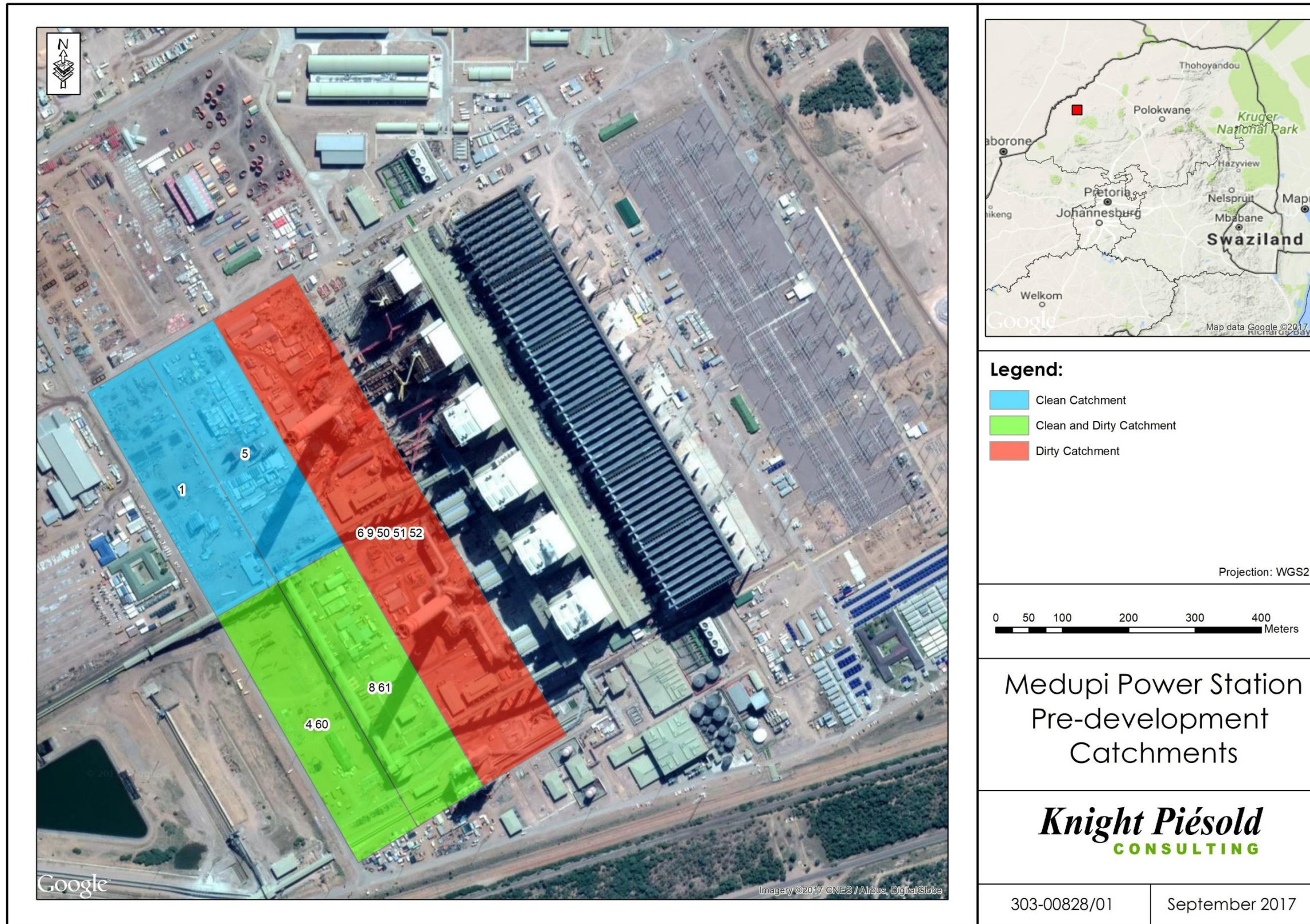

Figure 4: Delineated pre-development clean and dirty water catchments for the Main FGD area

5.2 Pre-development and Post-Development Flows

Section 5.1 above describes the existing stormwater management system and will be referred to as the pre-development scenario. The post-development catchment delineation was undertaken based on the following and will be termed the post development scenario:

- The existing and proposed FGD main area infrastructure was taken into account (based on drawing 0.84/28836 Medupi FGD Retrofit Project Site Arrangement).
- The FGD process produces a wastewater stream rich in chloride. This stream will be treated in the proposed WWTP (ZLD Plant, 0.84/28836 Medupi FGD Retrofit Project Site Arrangement) and will produce a chemical salt and chemical sludge as waste by-products (classified as type 1 waste). The permanent disposal site and method has not yet been established. A temporary solution is planned for the first few years of the FGD operation. This will include a temporary waste handling facility with some storage capacity, the waste will then be trucked to an offsite existing hazardous waste facility. The stormwater management in this area will be designed to cater for the potential spillages which may occur during transportation of the chemical salts and sludge. Details of the proposed temporary waste handling facility with some storage capacity were not available at the time of compiling the report, however it was indicated that the facility will be located in catchment 1.

Based on the considerations above two alternative stormwater management approaches may be adopted:

- Alternative 1: Catchment 1 and 5 were re-designated to dirty water catchments as shown in Figure 5 so as to contain any potential spillages which may occur during transportation of the chemical salts and sludge. The remaining catchment designations remain the same as the pre-development scenario. This updated scenario was termed the post development scenario for Alternative 1.
- Alternative 2: Catchment 1 and 5 remain as clean water catchments and it is assumed that the proposed WWTP will be maintained as a bunded system (Figure 8) and therefore be isolated. Where the potential spillages are kept within the WWTP footprint, this would negate the need to re-designate the catchments. This updated scenario was termed the post development scenario for Alternative 2.

The rational method was developed in the mid-19th century and is one of the most widely used methods for the calculation of peak flows for small catchments (< 15 km²). The formula indicates that $Q = CIA$, where I is the rainfall intensity, A is the upstream runoff area and C is the runoff coefficient. Q is the peak flow. The point precipitation was determined using the Depth-Area-Duration-Frequency relationships, HRU Report 2/78 (Midgley and Pitman, 1978). The post-development peak flows were then calculated for the two alternatives (using the rational method) by updating the percentage impervious areas for each of the catchments based on the existing and proposed FGD main area infrastructure.

5.2.1 Post-development flows Alternative 1

The post-development flood peak results were compared to the pre-development flood peaks in Table 4 below (See Appendix A).

The results indicate that the post-development flood peaks are less than the pre-development flood peaks; this was due to the conservative approach adopted in the pre-development scenario as more development of the catchment was anticipated. This was done to allow for substantial development within the terrace area without having to increase the stormwater system capacity once the final infrastructure layout is developed. The results show that approximately 35% of the total conveyance capacity is utilized.

Catchment 1 and 5 were re-designated to dirty water catchments, therefore the runoff generated from these catchments will have to be conveyed to the Dirty Water Dam. This will be done by using the existing clean water infrastructure (kerb inlets and pipelines) to collect runoff directly from the catchment and then one of two approaches can be adopted as shown in Figure 6 and Figure 7:

- Option 1: The existing clean water pipeline is connected into the dirty water pipeline as shown in Figure 6. The existing dirty water pipelines were then evaluated to determine if they have sufficient capacity to convey the re-designated catchment peak flows. The combined flood peak for the catchments was 1.03 m³/s (0.94 m³/s comes from catchments 1 and 5). The total capacity of the pipeline which will be connected to is 3.21 m³/s (1.2 m diameter pipeline at 1:200 fall) of which 2.95 m³/s is already utilised by the dirty water system. Therefore there is insufficient capacity to tie into the existing dirty water system.

- Option 2: The existing clean water pipeline is converted into dirty water line and extended via a new pipeline 1.2 m in diameter (1.4 km long) which will convey the dirty water to the Dirty Water Dam directly as shown in Figure 7.

Due to the findings mentioned above option 2 is recommended. Based on the re-designation of the catchments areas, 20% of the total dirty water catchment areas will now be added to the dirty water system. It is therefore anticipated that the existing Dirty Water Dam (102 00 m³ capacity) will have insufficient capacity to store the new dirty water runoff volumes. Additional dirty water storage will be required. This has not been sized as it is not part of the scope. The Dirty Water Dam capacity would have to be validated using a water balance so as to take into account the demands on the Dam. The 9% reduction in clean water areas indicates that the Clean Water Dam (133 400 m³ capacity) will have sufficient capacity to cope with the proposed FGD infrastructure.

5.2.2 Post-development flows Alternative 2

The post-development flood peak results are compared to the pre-development flood peaks in Table 5 below (See Appendix A).

The results indicate that the post-development flood peaks are less than the pre-development flood peaks; this was due to the conservative approach adopted in the pre-development scenario as more development of the catchment was anticipated. This was done to allow for substantial development within the terrace area without having to increase the stormwater system capacity once the final infrastructure layout is developed. The results show that approximately 35% of the total conveyance capacity is utilized. The reduction in flood peaks indicates that the Clean and Dirty Water Dams (102 00 m³ capacity for the Dirty Water Dam and 133 400 m³ capacity for the Clean Water Dam) have sufficient capacity to cope with the proposed FGD infrastructure.

It is therefore recommended that Alternative 1 be implemented so as to account for the potential spillages which may occur during transportation of the chemical salts and sludge from the WWTP to the storage areas. Option 2 (of Alternative 1) is recommended as the existing dirty water pipeline infrastructure has inadequate capacity to carry the proposed additional flow necessitating an additional pipeline.

Table 4: Pre-development and Post Development Flood Peaks Alternative 1

Catchments	Pre-development scenario Clean/Dirty designation	Post-development scenario Clean/Dirty designation	Area (ha)	Flow Length (m)	% Impervious Pre-development	% Impervious Post-development	Slope (m/m)	Q _{Pre-dev} (m ³ /s)	Q _{Post-dev} (m ³ /s)	% Capacity Utilized
1	Clean	Dirty	4.81	300	60	10	0.005	1.24	0.497	40
5	Clean	Dirty	3.99	300	60	30	0.005	1.028	0.441	43
4	Clean	Clean	2.44	300	70	6	0.005	0.672	0.258	38
60	Dirty	Dirty	2.1	200	80	20	0.005	0.661	0.251	38
8	Clean	Clean	2.4	300	70	12	0.005	0.727	0.258	35
61	Dirty	Dirty	2.1	200	80	15	0.005	0.727	0.251	35
6	Clean	Clean	0.88	160	50	30	0.005	0.276	0.113	41
9	Clean	Clean	0.88	160	50	30	0.005	0.276	0.113	41
50	Dirty	Dirty	5.06	200	90	42	0.005	1.848	0.635	34
51	Dirty	Dirty	5.06	200	90	42	0.005	1.848	0.635	34
52	Dirty	Dirty	5.06	200	90	42	0.005	1.848	0.635	34

Table 5: Pre-development and Post Development Flood Peaks Alternative 2

Catchments	Pre-development scenario Clean/Dirty designation	Post-development scenario Clean/Dirty designation	Area (ha)	Flow Length (m)	% Impervious Pre-development	% Impervious Post-development	Slope (m/m)	Q _{Pre-dev} (m ³ /s)	Q _{Post-dev} (m ³ /s)	% Capacity Utilized
1	Clean	Clean	4.81	300	60	10	0.005	1.24	0.497	40
5	Clean	Clean	3.99	300	60	30	0.005	1.028	0.441	43
4	Clean	Clean	2.44	300	70	6	0.005	0.672	0.258	38
60	Dirty	Dirty	2.1	200	80	20	0.005	0.661	0.251	38
8	Clean	Clean	2.4	300	70	12	0.005	0.727	0.258	35
61	Dirty	Dirty	2.1	200	80	15	0.005	0.727	0.251	35
6	Clean	Clean	0.88	160	50	30	0.005	0.276	0.113	41
9	Clean	Clean	0.88	160	50	30	0.005	0.276	0.113	41
50	Dirty	Dirty	5.06	200	90	42	0.005	1.848	0.635	34
51	Dirty	Dirty	5.06	200	90	42	0.005	1.848	0.635	34
52	Dirty	Dirty	5.06	200	90	42	0.005	1.848	0.635	34

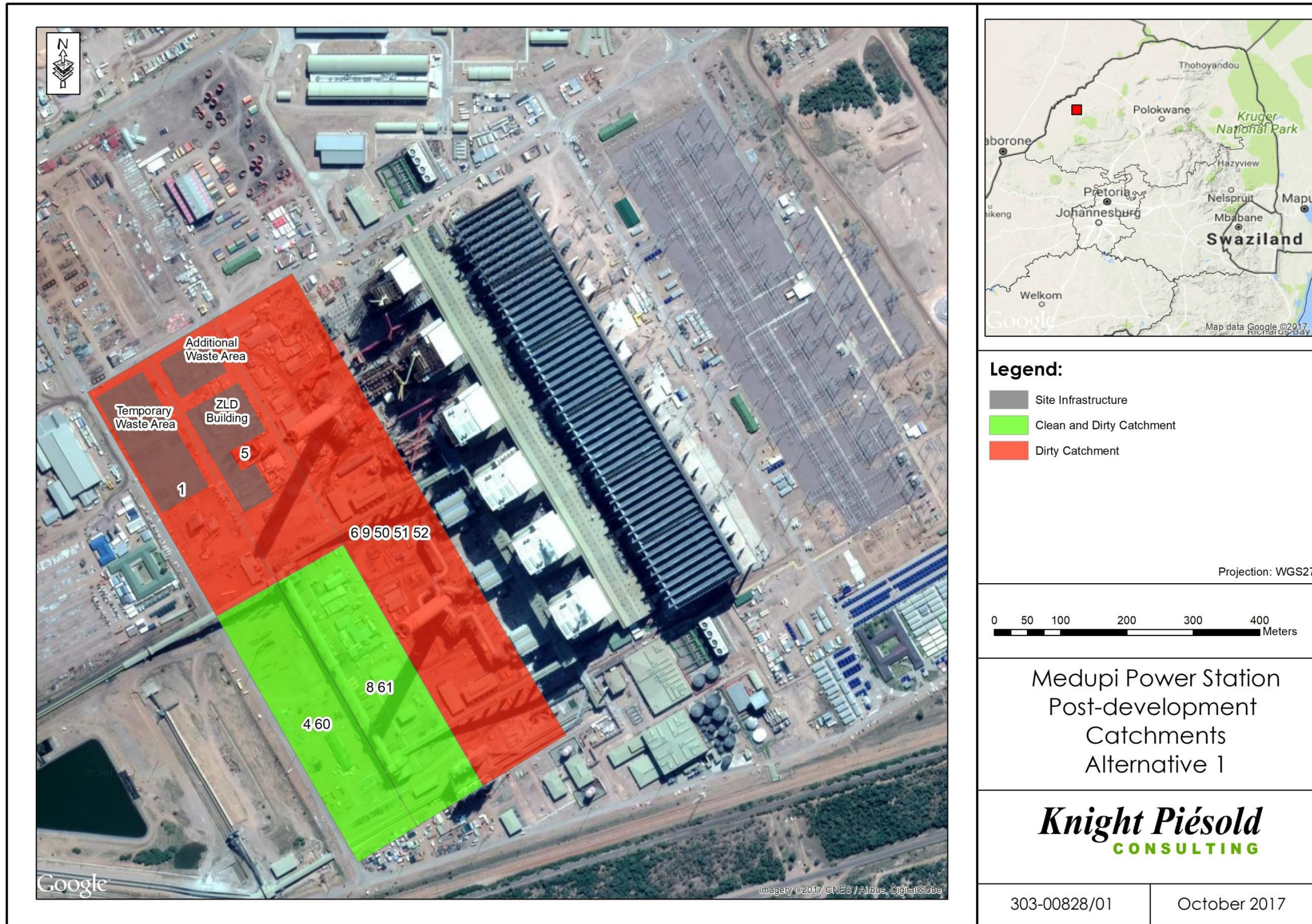

Figure 5: Catchment 1 and 5 were re-designated to dirty water catchments (Alternative 1)

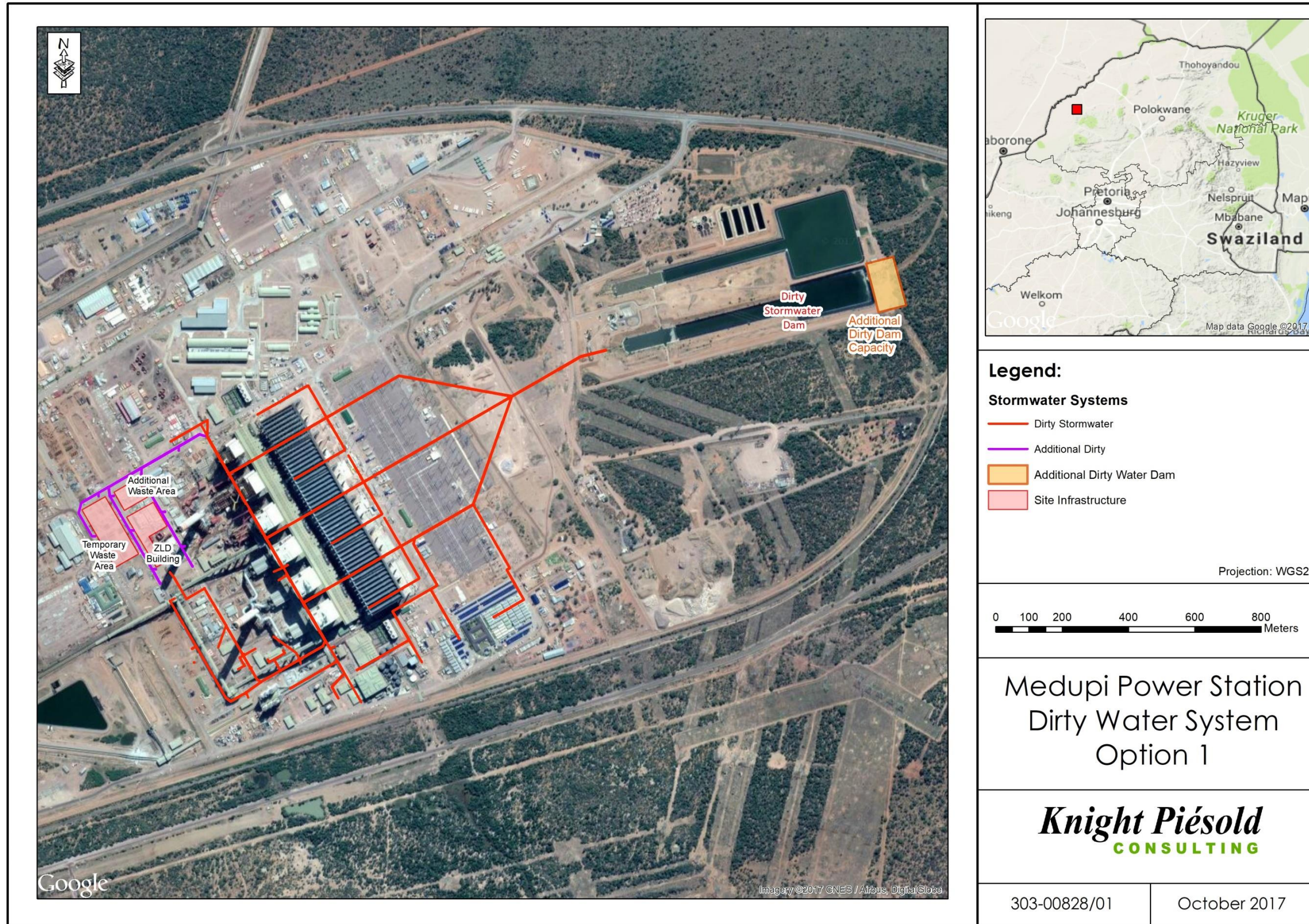

Figure 6: Option 1- Tie in into existing dirty water system

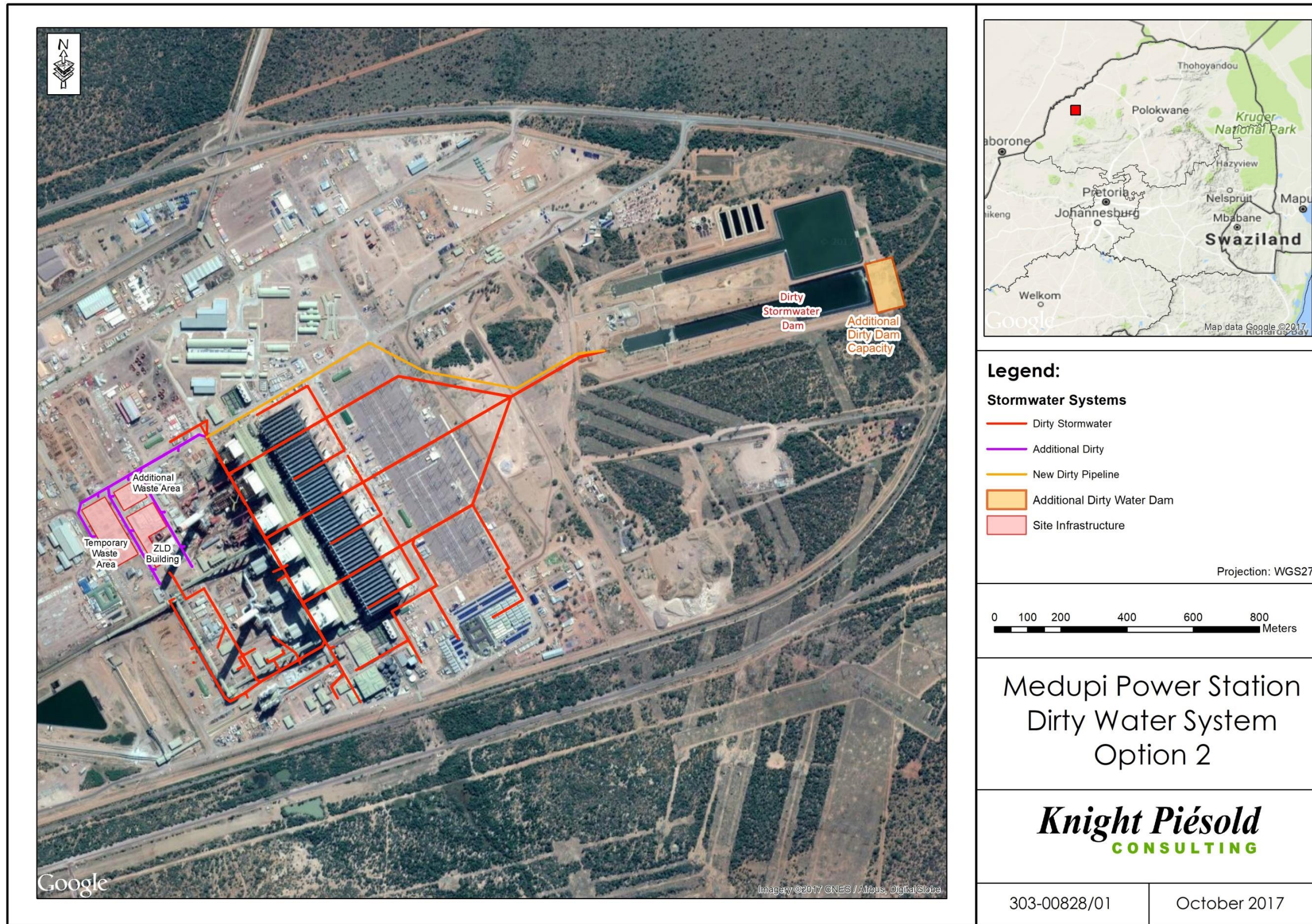

Figure 7: Option 2- New pipeline to the Dirty Water Dam

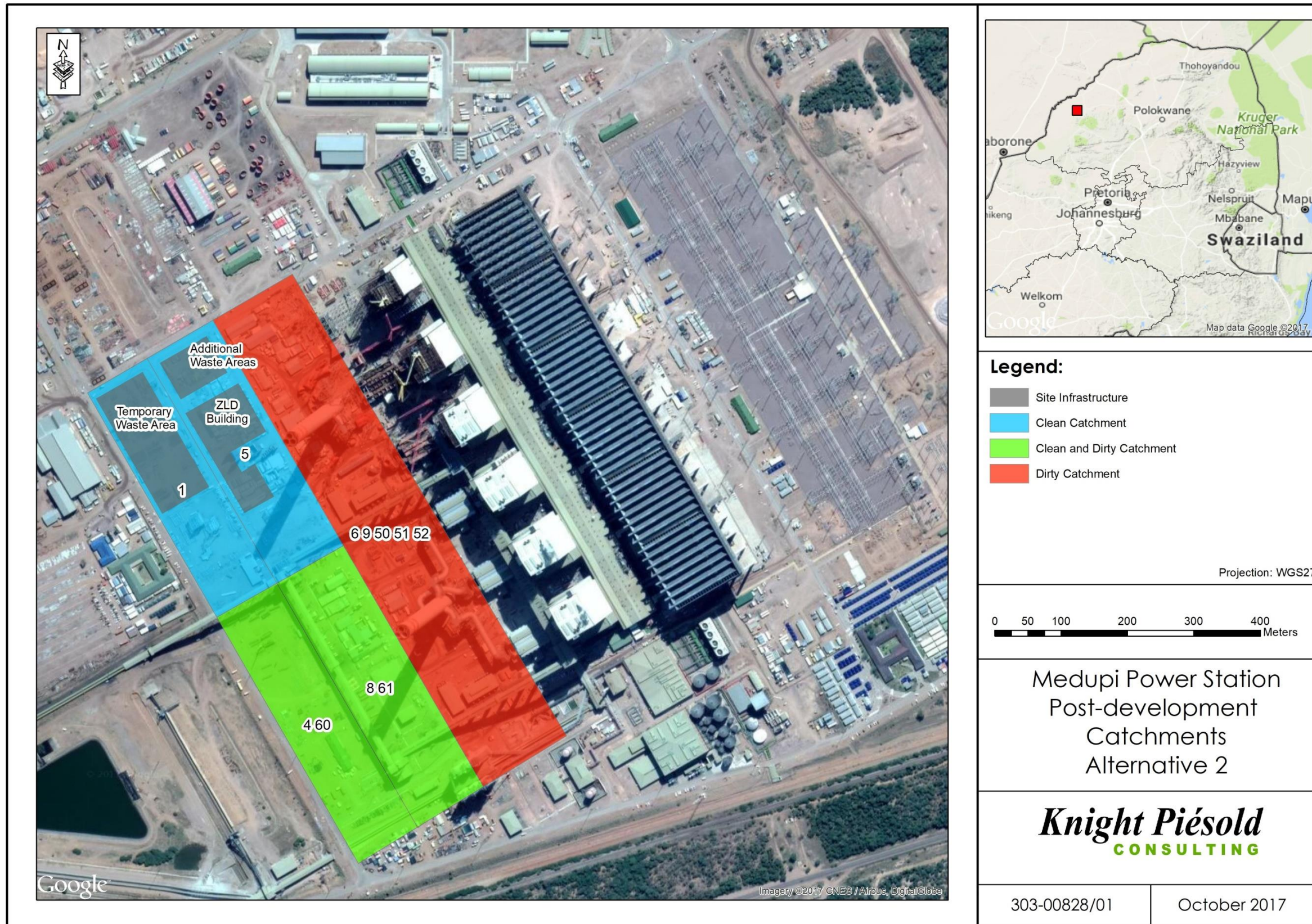

Figure 8: Catchment designated remains the same as pre-development scenario (Alternative 2)

5.3 Truck Loading Facility for Immediate Gypsum Offtake

The proposed layout of the truck loading facility for immediate gypsum offtake and the associated clean and dirty water stormwater is shown in Figure 9. The layout of the facility is based on the roads design, which takes into account the required turning circles and traffic management; described in more detail in later in this report.

The facility comprises of the access road slab and the open area enclosed by the roads. Based on the Waste Classification Assessment of Ash and FGD Wastes for the Medupi Power Station Report (Zitholele, 2015) the FGD Gypsum product is classified as a dirty area (Type 3 Waste). The open area enclosed by the road will remain a clean water catchment.

The stormwater management philosophy (as shown in Figure 9) for the truck loading facility (for immediate gypsum offtake) is as follows:

- The stormwater collected on the access roads will be classified as dirty water. The stormwater will flow towards the catchpit (located at the low point left of the offtake structure) via the road. The road will have a concrete slab layer and shall, for the most part, follow the terrace slope of 0.5%. The area under the offtake is designed with a depression to ensure that the dirty stormwater remains bunded. The stormwater collected in the catchpit will then flow into a sediment trap and flow via a gravity fed pipeline (600mm diameter and 1:100 slope) to the nearest dirty water line manhole.
- The area enclosed by the road is classified as a clean water catchment. This water will be collected via kerb inlets and conveyed via a gravity fed pipeline to the nearest manhole. It was found that the proposed road layout encroached on the nearest manhole (a kerb inlet was also located at this point). Therefore it was proposed that the existing kerb inlet be converted to a junction box, which will receive the flow from the clean water area and convey it into the existing clean water line. A new kerb inlet is proposed to ensure that the Road 3 drainage is maintained.

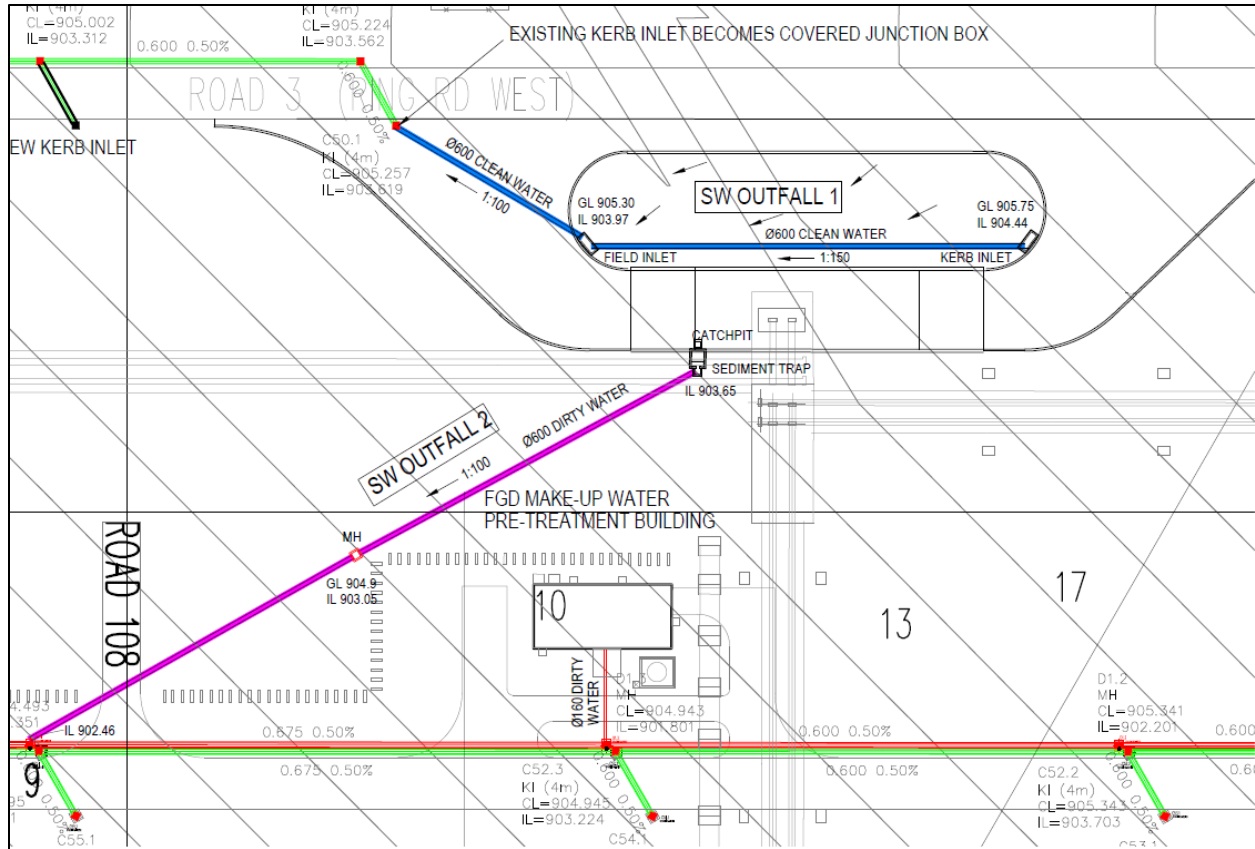

Figure 9: Proposed layout of truck loading facility and associated stormwater management

The rational method inputs and results are shown in Table 6. The 1:50 year peak flows were then used to size the associated drainage pipelines. The results are shown in Table 7 (See Appendix A).

Table 6: Rational method inputs and results

Rational Method	Concrete Slab Area/Road	Area enclosed by road
Size of Catchment, A (ha)	0.31	0.13
Longest Watercourse, L (km)	0.118	0.072
Average Slope, S_{av} (m/m)	0.005	0.005
Combined run-off coefficient, CT	0.95	0.348
Roughness Coefficient	0.02	0.1
Mean Annual Rainfall (mm)	465	465

Time of Concentration, t_c (hours)	0.12	0.21
2-year return period daily rainfall, M (mm)	54.9	54.9
Days of Thunder per year, R (days/year)	50	50
Point Rainfall (mm)	38.8	51.5
Average Intensity (mm/hr)	314.7	248.0
Peak flow (m^3/s)- Q_{50}	0.26	0.03

Table 7: Pipeline design checks

Pipe ID	Design Flow Rate (l/s)	Velocity (m/s)	Pipe Characteristics, Class 34	Pipe Capacity @ 0.8D (l/s)	Sufficient Capacity
SW Outfall 1	0.03	0.89	600mm Concrete Class 100D @ 1:150 Fall	0.41	Sufficient
SW Outfall 2	0.26	1.75	600mm Concrete Class 100D @ 1:100 Fall	0.5	Sufficient

The operational procedure is as follows:

- The area under the offtake is designed with a depression to ensure that the dirty stormwater remains bunded. Any gypsum that spills during the loading should be cleaned to ensure the catchpit capacity is maintained and no spills occur from the bunded area during rainfall.
- The stormwater collected in the catchpit will then flow into a sediment trap. The sediment trap should be regularly emptied (monthly) to ensure the capacity of the system is maintained.
- The area enclosed by the road will be collected via kerb inlets and conveyed via a gravity fed pipeline to the nearest manhole. The kerb inlets should be maintained to ensure that no blockages occur which may result in flooding.

5.4 Drainage Philosophy for the Oil Based Transformers Absorber Substations and FGD Common Substation

The current drainage philosophy at Medupi PS is to utilise an oil capture pit with a honey sucker removing the oil when required was maintained in the design. This philosophy was maintained

as it provides the most practical solution for removing the oil effectively. The oil transformer areas was designed to have a concrete slab base (100mm deep) and will be bunded to ensure no oil spills from the area. The minimum height of the bund was determined by the capacity of oil within the transformers and the 1:50 year recurrence interval storm (24 hour duration) (fire water was omitted as the information is not available) and is shown in Table 8. The slab was designed sloped so as to drain towards a sump at a 1:100 slope. The oil trap will be designed to allow for cleaning via a honey sucker. The pipelines connecting the bunded areas to the central oil traps have been sized to convey the peak runoff rate from a 1:50 year recurrence interval storm (24 hour duration); Table 9 shows the results of the analysis (see Appendix A).

The operational procedure is as follows:

- The oil capture pits should be visually inspected regularly to identify any cleaning or repairs needed.
- The oil capture pits should be regularly emptied (it should be kept empty as possible) with a honey sucker, specifically after any rainfall event. Remove entire contents when emptying.

Table 8: Calculated minimum bund height

Pump Building	Transformer Rating	Total Oil Volume (l)	Area Designated (m ²)	1 in 50 year Rainfall Volume	Min. Bund Height (m)
Absorber Pump Building	10MVA Unit1-6 11/6 9KV FGD Board 1-6 TRFR	5868	51.84	6.89	0.25
FGD Common Pump Station Building	15MVA 9KV FGD Common TRFR	7172	69.12	9.19	0.24

Table 9: Pipeline design checks

Pipe ID	Design Flow Rate (l/s)	Design Velocity (m/s)	Pipe Characteristics, Class 34	Pipe Capacity @ 0.8D (l/s)	Sufficient Capacity/Insufficient Capacity
Oil Trap A	14.0	0.8	160mm uPVC @ 1:200 Fall	14.6	Sufficient Capacity
Oil Trap B	10.2	0.7	160mm uPVC @ 1:200 Fall	14.6	Sufficient Capacity
Oil Trap C	21.1	0.9	200mm uPVC @ 1:200 Fall	26.5	Sufficient Capacity
Oil Trap D	14.0	0.8	160mm uPVC @ 1:200 Fall	14.6	Sufficient Capacity
Oil Trap E	10.2	0.7	160mm uPVC @ 1:200 Fall	14.6	Sufficient Capacity
Oil Trap F	14.0	0.8	160mm uPVC @ 1:200 Fall	26.5	Sufficient Capacity
Oil Trap G	14.0	0.8	160mm uPVC @ 1:200 Fall	14.6	Sufficient Capacity

5.5 Sump Water Drainage

The conceptual designs included the identification of suitable existing drainage connection points in the vicinity of the Common Pump Building and Raw Water Pre-treatment building for the drainage of process water collected in these building sumps (084/37847, General Arrangement, FGD Common Pump Building and 084/36759, General Arrangement, FGD Makeup Water Pre-treatment Building). The proposed connection points are shown in Figure 10 and Figure 11.

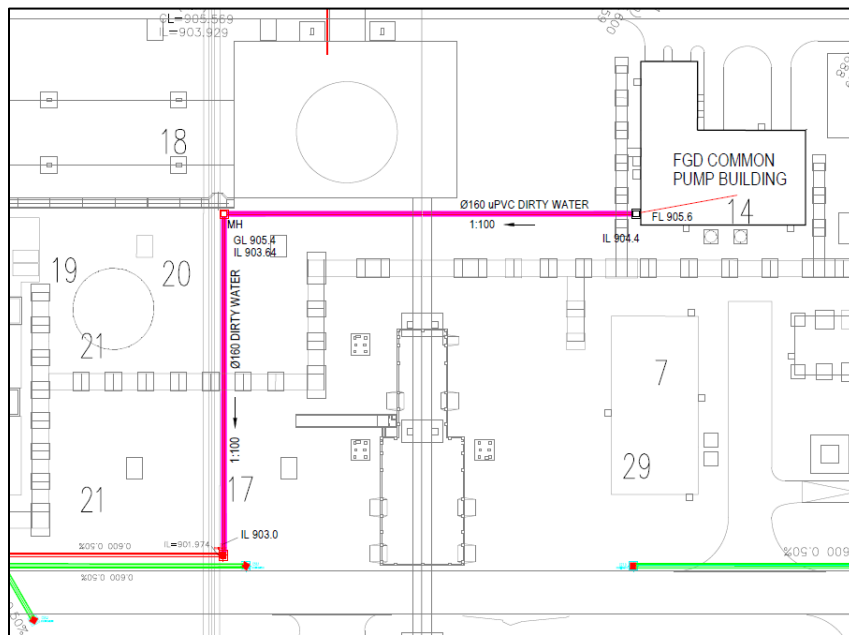

Figure 10: Layout plan showing the identified sump connection point for the FGD Common Pump Building

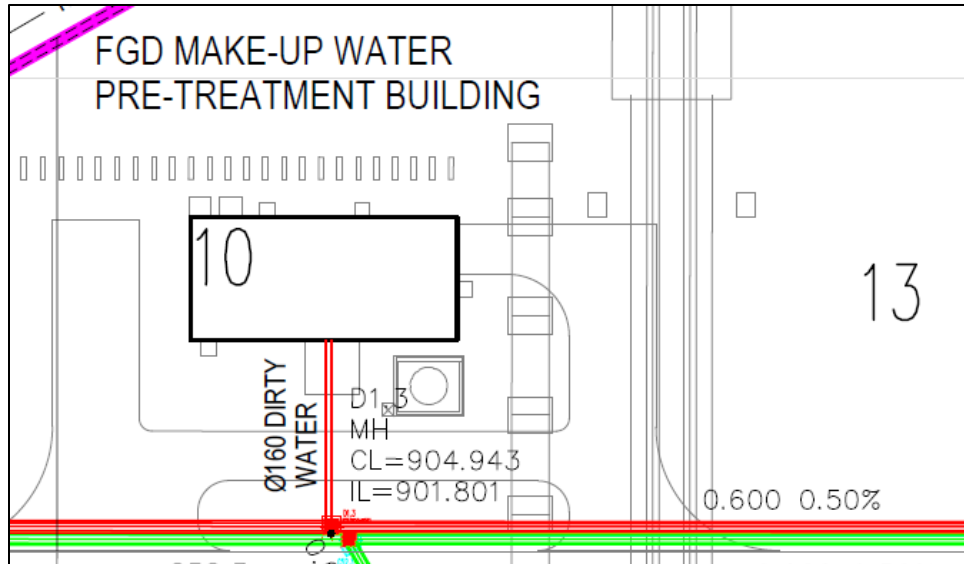

Figure 11: Layout plan showing the identified sump connection point for the FGD Common Pump Building

The pipes from the sumps to the selected drainage connection points were sized based on the continuous operation flows:

- FGD Common Pump Building: 2 x 100% capacity pumps at 5m³/hr
- Raw Water Pre-Treatment Building: 2 x 100% capacity pumps at 129m³/hr

A maximum sump depth of 2m was taken into account; no sizing of the sump was carried out as it is not part of the scope. The cheapest option would be a gravity fed line from the sump to the dirty water line. This option was checked taking into account the minor and major losses along the proposed routes. The results from the analysis are shown in Table 10 below. The results indicate that the gravity fed line is feasible as the 2m head of water in the sump is sufficient to overcome the losses. A minimum sump depth of 1.1m will ensure that the gravity fed line is feasible.

Table 10: Gravity fed pipeline calculation results

Pipeline	Q (m ³ /s)	Length	Pipe Diameter (m)	Area (m ²)	Average Velocity (m/s)	Re	Turbulent/Laminar	f	Friction Losses (m)	Local Losses coefficient	Local Losses (m)	Total losses (m)	Total Head Available (m)
Pipeline1: FGD Common Pump Building (@129m ³ /hr each)	0.072	163.7	0.2	0.031	2.3	458366	Turbulent	0.0032	0.69	1.5	0.40	1.09	2.00
Pipeline 2: FGD Makeup Water Pre-treatment area (@5m ³ /hr each)	0.0028	10	0.11	0.010	0.3	32153	Turbulent	0.0057	0.002	1.5	0.007	0.01	2.00

6 SEWAGE INFRASTRUCTURE DESIGN

The conceptual design involved the sewage drainage from the sources identified below. The design convey sewage into the existing sewage network from the sources identified and then to the existing Sewage Treatment Plant at Medupi Power Station.

The following buildings required sewage drainage. These comprise of ablutions and safety showers.

- Common Pump Building, 1 x safety shower, Refer to drawing 0 84/ 37847, General Arrangement, FGD Common Pump Building;
- Raw Water Pre-Treatment Building, 1 x safety shower; 0 84/ 36759, General Arrangement, FGD Makeup Water Pre-treatment Building;
- Raw Water Pre-Treatment Area, 1 x safety shower, 0 84/ 36244, General Arrangement, FGD Makeup Water Pre-treatment Area;
- Proposed ZLD Building, 3 x safety showers and ablutions; 0 84/ 37689, General Arrangement, FGD ZLD Treatment Building.

6.1 Existing Sewer Reticulation Infrastructure

The existing sewer reticulation network was designed for the following areas (as shown in Figure 12):

- The contractors yards (yard numbers 1 to 42) the number, area and location of which are amended from time to time;
- The central power island area (Auxiliary Bay);
- Four (4) temporary ablution facilities;
- The “Eskom Precinct” comprising an auditorium, simulator and training building, fire station and a medical centre, site canteen and administration office complex;
- The permanent access control building (secure entrance gate), and
- The workshop area located west of the central power island.

All sewers concentrate at a single discharge point; currently this end point is located immediately north of the air-cooled condensers yard (contractors yard number 11). Ultimately the topography and terrace levels prevent discharge at this location being accomplished by gravity alone therefore several pump stations have been introduced.

From the final discharge point sewerage will be pumped to a sewage treatment works.

6.2 Pre-development and Post-Development Sewage Flows

The following guidelines and standards were used in the calculation of the pre-development and post-development sewage flows:

- SANS 10400 Part P – Drainage;
- Red Book Guidelines for Human Settlement Planning and design (CSIR. 2005);
- Manual on the Design of Small Sewage Works, (WRC, 2009).

6.2.1 Pre-development Sewage Flows

The pre-development sewage peak flows were designed based on the baseline data provided by Eskom:

- A total water demand of 3 Mℓ/d,
- A maximum on-site population of 6000 people during construction,
- A minimum on-site population of 300 – 1000 people after completion of construction,
- Gross areas of contractor yards per information supplied on drawing 084/4: Contractors Sites, Water and Electrical Construction Ring Main Layout, and
- A summary of sanitary fittings and fixtures as supplied by the architect from Eskom Generation.

The methodology used in the estimation of the sewage hydraulic load was to estimate a particular sites water demand (annual average daily demand) modified by a percentage return sewage flow.

The water demand was based on the gross floor area of the site under consideration, which was obtained by using an approximated Floor Space Ratio (FSR), and guideline unit water demand of 400ℓ/100 m²; which is a typical demand used for dry industry.

The hydraulic load for the temporary ablution facilities was based on unit water demands per capita for the number of sanitary fixtures and fittings as noted by Eskom Generation. Table 11 below shows the design criteria used in estimating the hydraulic loads. The hydraulic load for the site was calculated to be 1.5 Mℓ/d (Average Dry Weather Flow (ADWL) load).

Table 11: Design criteria used in estimating hydraulic loads

Criteria	Water	Sewer
Floor Space Ratio	0.25	-
Unit Water Demands		
A. Dry Industry	400ℓ/100m ²	-
B. Sanitary Fixtures and Fittings		
i.) wash hand basin	30ℓ/capt/day	-
ii.) water closet	53ℓ/capt/day	-
iii.) urinal	8ℓ/capt/day	-
Percentage return sewage flow	-	80% to 100%
System losses	10%	-
Summer Peak Factor	1.5	-
Daily Peak Factor	3	3 (Harmon Formula)
Allowance for Extraneous inflow	-	15%

“Sewer” software package that simulates a least cost branched network design was then used in the analysis of the flows, limiting grades and velocities.

The sewage treatment plant capacity was designed to be ±1.5 Mℓ/d, taking into account the peak construction period and based on the hydraulic loads estimated.

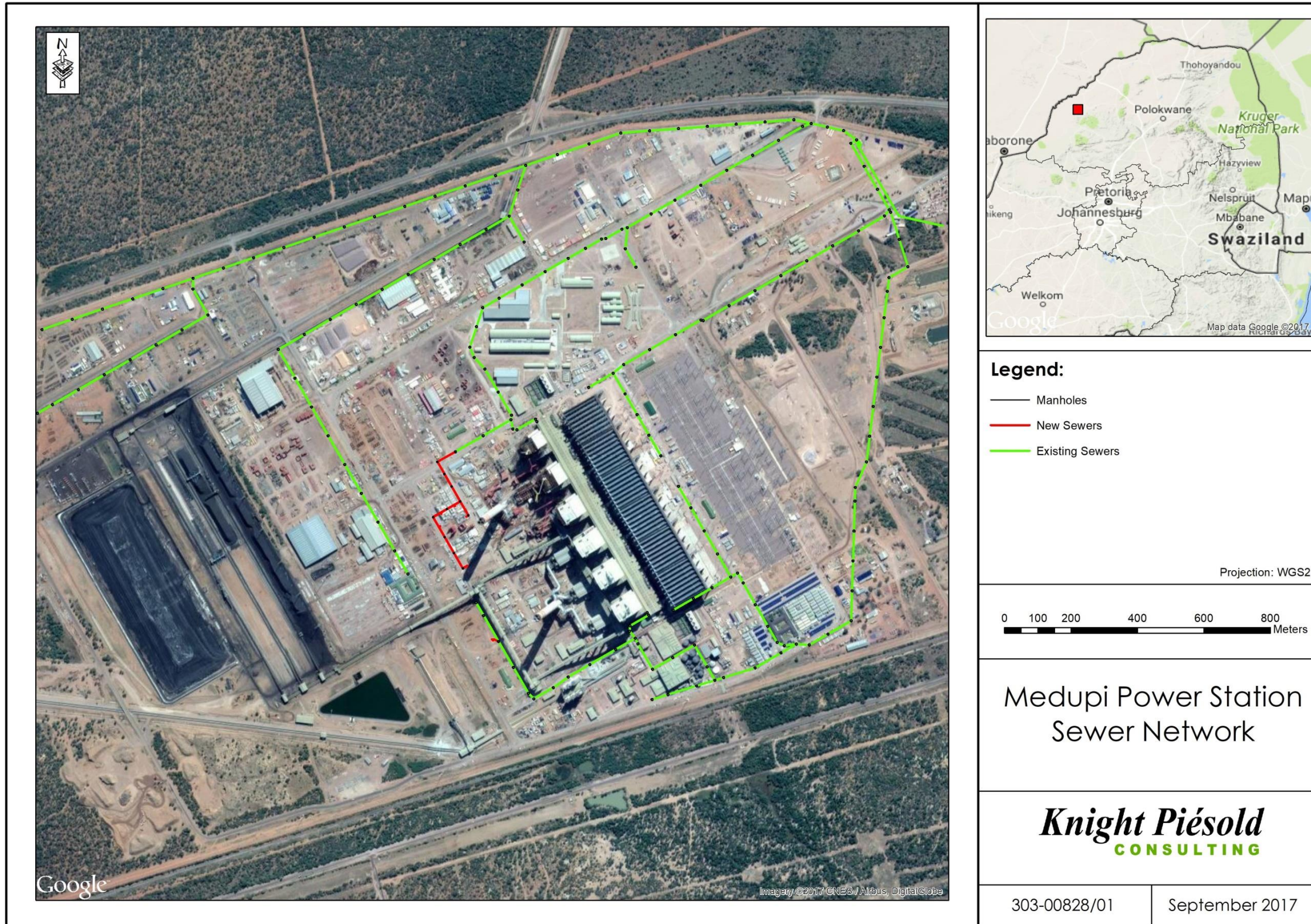

Figure 12: Existing sewer reticulation network

6.2.2 Post-development Sewage Flows

The methodology employed in the calculation of the post-development peak flows was based on SANS 10400 Part P – Drainage. The standard prescribes peak flows for dwellings with full internal water reticulation. This approach was adopted as the sewage peak flows only include ablutions and safety showers as per the architecture drawings for the FGD Makeup Water Pre-treatment Building, the FGD Common Pump Building and the ZLD Building. SANS 10400 Part P – Drainage does not prescribe a peak flow rate for safety showers, the peak flows per safety shower were obtained from Spraydench Emergency Showers Suppliers. The peak flows are shown in Table 12 below.

Table 12: Post-development peak flow rates

Building	Infrastructure	Prescribed Peak Flow Rates	Post-development Peak Flow Rate (l/s)
FGD Makeup Water Pre-treatment Building	2x Safety Showers (1 located within the building and one outside)	1.26l/s per safety shower	2.52
FGD Common Pump Building	1x Safety Shower	1.26l/s per safety shower	1.26
ZLD Building	3x Safety Shower and Ablutions	1.26l/s per safety shower	3.78
		1800l/d for Ablutions	0.02

6.3 Sewage Drainage Design

The layout plans for the proposed sewage network is shown in Figure 13 (FGD Make-up Water Pre-treatment Building) and Figure 14 (FGD Common Pump Building and ZLD Building). The proposed connection points are MH152 and MH89. The sewage pipelines were designed to take the peak flows shown in Section 6.2, the results are shown in Table 13 below.

A comparison of the pre-development and post-development peak flows was undertaken to determine if the existing sewage network is capable of conveying the post-development flows (Table 14) (See Appendix B for detailed calculations). It was found that the existing sewage

network is capable of conveying the post-development peak flows. This result indicates that the existing Sewage Treatment Plant capacity is capable of accommodating the additional flows.

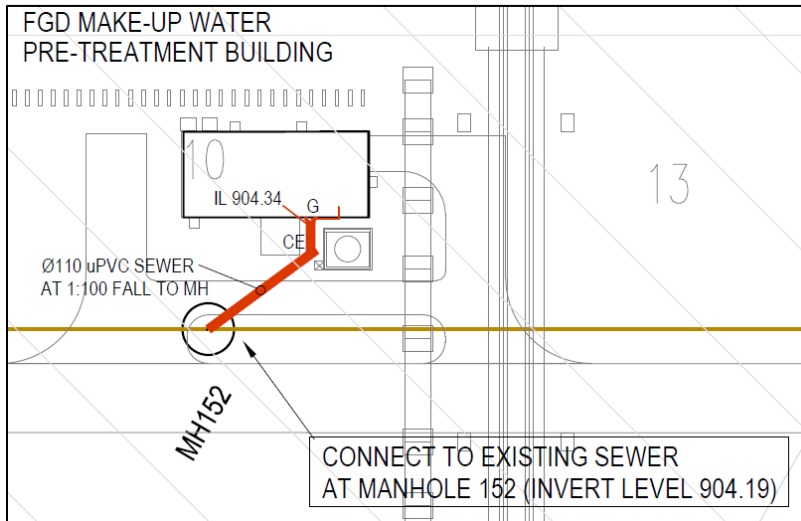

Figure 13: Layout plan for sewage network for the FGD Make-up Water Pre-treatment Building

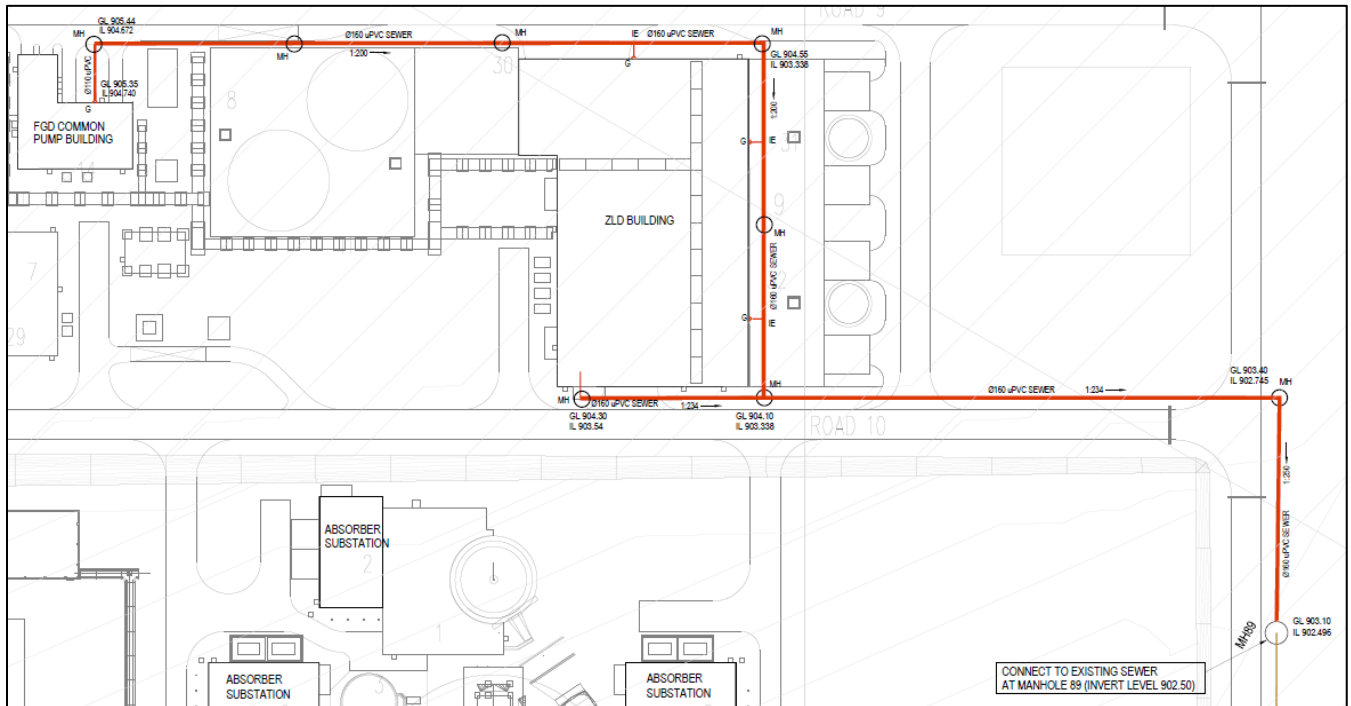

Figure 14: Layout plan for sewage network for the FGD Common Pump Building and ZLD Building

Table 13: Pipeline design checks

Pipe ID	Design Flow Rate (l/s)	Design Velocity (m/s)	Pipe Characteristics, Class 34	Pipe Capacity @ 0.8D (l/s)	Sufficient Capacity/Insufficient Capacity
FGD Pre-Treatment Building to MH152	2.52	0.3	110mm uPVC @ 1:100 Fall	7.27	Sufficient Capacity
FGD Common Pump Building to MH1	1.26	0.07	160mm uPVC @ 1:200 Fall	13.78	Sufficient Capacity
ZLD Building, Shower 1 to MH6	5.04	0.28	160mm uPVC @ 1:100 Fall	13.78	Sufficient Capacity
ZLD Building, Ablution to MH6	0.02	0.001	160mm uPVC @ 1:234 Fall	12.74	Sufficient Capacity
ZLD Building, MH6 to MH7	5.06	0.28	160mm uPVC @ 1:234 Fall	12.74	Sufficient Capacity
ZLD Building, MH7 to MH89	5.06	0.28	160mm uPVC @ 1:250 Fall	12.32	Sufficient Capacity

Table 14: Comparison of pre-development and post-development peak flows

Connection Point	Q _{Pre-development} (l/s)	Q _{Post-development} (l/s)	Q _{Capacity} (l/s)	% Capacity Utilized
MH89-160mm uPVC @1:67	1.24	6.3	21.81	29
MH152- 160mm uPVC @1:200	0.03	2.55	11.61	22

7 COSTS FOR THE PROPOSED FGD STORMWATER AND SEWER INFRASTRUCTURE

Table 15 below shows the costs for the proposed FGD stormwater and sewer infrastructure for Alternative 1 (re-designation of catchment 1 and 5) option 2. This includes the additional pipeline to the Dirty Water Dam.

Table 15: Cost of stormwater and sewer infrastructure Alternative 1 Option 2

Item No.	Description	Unit	Quantity	Rate	Amount
1	Road Crossings (Includes reinstatement of road)				
	Road Crossings	No.	4	R 50 000	R 200 000.00
2	Trench excavation and backfilling				
	(a) All materials	m ³	3788	R 103	R 389 504.62
	(b) Extra over for rock	m ³	947	R 154	R 146 068.58
	(c) Bed preparation	m ³	1750	R 51	R 89 985.00
3	Pipelines (supply and lay)				
	Clean Water				
	600mm Concrete	m	50	R 1 000	R 50 000.00
	Dirty Water				
	160mm uPVC, Class 34	m	30	R 88	R 2 627.40
	200mm uPVC, Class 34	m	30	R 136	R 4 092.60
	600mm Concrete	m	45	R 550	R 24 750.00
	1200mm Concrete	m	1400	R 1 500	R 2 100 000.00
	Sewer				
	110mm uPVC, Class 34	m	15	R 39	R 591.00
160mm uPVC, Class 34	m	180	R 88	R 15 764.40	
4	Concrete				
	Concrete (including formwork)	m ³	50	R 3 085	R 154 250.00
	Reinforcement	t	7	R 2 400	R 16 800.00

	Manholes complete with base, walls, roof, step irons, cover and frame				
5	1 x 1 x 2m deep Cast Iron Heavy Duty	No.	2	R 10 000	R 20 000.00
	1250mm x 2m deep Diameter Cast Iron Heavy Duty	No.	40	R 35 000	R 1 400 000.00
	Delivery				R 16 500.00
6	Dealing with Services (% of 1-5)	%		5%	R 231 546.68
7	Landscaping (% of 1-5)	%		5%	R 231 546.68
8	Miscellaneous (% of 1-5)	%		20%	R 926 186.72
9	SUB-TOTAL A				R 6 020 213.67
	Preliminary and General (% of sub-total A)	%		30%	R 1 806 064.10
10	SUB-TOTAL B				R 7 826 277.78
	Contingencies (% of sub-total B)	%		30%	R 2 347 883.33
11	SUB-TOTAL C				R 10 174 161.11
	Planning design and supervision (% of sub-total C)	%		10%	R 1 017 416.11
12	SUB-TOTAL D				R 11 191 577.22
	VAT (% of sub-total D)	%		14%	R 1 566 820.81
	TOTAL PROJECT COST				R 12 758 398.03

Table 16 below shows the costs for the proposed FGD stormwater and sewer infrastructure for Alternative 2 (designation of catchment 1 and 5 remains clean).

Table 16: Cost of stormwater and sewer infrastructure Alternative 2

Item No.	Description	Unit	Quantity	Rate	Amount
1	Road Crossings (Includes reinstatement of road)				

	Road Crossings	No.	4	R 50 000.00	R 200 000.00
2	Trench excavation and backfilling				
	(a) All materials	m ³	291	R 102.83	R 29 923.53
	(b) Extra over for rock	m ³	72	R 154.25	R 11 106.00
	(c) Bed preparation	m ³	350	R 51.42	R 17 997.00
3	Pipelines (supply and lay)				
	Clean Water				
	600mm Concrete	m	50	R 1 000.00	R 50 000.00
	Dirty Water				
	160mm uPVC, Class 34	m	30	R 87.58	R 2 627.40
	200mm uPVC, Class 34	m	30	R 136.42	R 4 092.60
	600mm Concrete	m	45	R 550.00	R 24 750.00
	Sewer				
	110mm uPVC, Class 34	m	15	R 39.40	R 591.00
160mm uPVC, Class 34	m	180	R 87.58	R 15 764.40	
4	Concrete				
	Concrete (including formwork)	m ³	50	R 3 085.00	R 154 250.00
	Reinforcement	t	7	R 2 400.00	R 16 800.00
5	Manholes complete with base, walls, roof, step irons, cover and frame				
	1 x 1 x 2m deep Cast Iron Heavy Duty	No.	2	R 10 000.00	R 20 000.00
	1250mm x 2m deep Diameter Cast Iron Heavy Duty	No.	12	R 35 000.00	R 420 000.00
	Delivery				R 16 500.00
6	Dealing with Services (% of 1-4)	%		5%	R 49 220.10
7	Landscaping (% of 1-4)	%		5%	R 49 220.10
8	Miscellaneous (% of 1-4)	%		20%	R 196 880.39
9	SUB-TOTAL A				R 1 279 722.51

	Preliminary and General (% of sub-total A)	%		30%	R 383 916.75
	SUB-TOTAL B				R 1 663 639.26
	Contingencies (% of sub-total B)	%		30%	R 499 091.78
10	SUB-TOTAL C				R 2 162 731.04
	Planning design and supervision (% of sub-total C)	%		10%	R 216 273.10
11	SUB-TOTAL D				R 2 379 004.14
	VAT (% of sub-total D)	%		14%	R 333 060.58
12					
	TOTAL PROJECT COST				R 2 712 064.72

8 WATER BALANCE

The FGD area contributes water to the existing site water system as follows:

- Surface water runoff generated from the clean water catchments will be conveyed to the Clean Water Dam;
- Surface water runoff generated from the dirty water catchments will be conveyed to the Dirty Water Dam;
- The sewer water from the Common Pump Building (1 x safety shower) will be conveyed to the Sewage Treatment Plant;
- The sewer water from the Raw Water Pre-Treatment Building (1 x safety shower) will be conveyed to the Sewage Treatment Plant;
- The sewer water from the Raw Water Pre-Treatment Area (1 x safety shower) will be conveyed to the Sewage Treatment Plant;
- The sewer water from the Proposed ZLD Building (3 x safety showers and ablutions) will be conveyed to the Sewage Treatment Plant.

As the FGD area is only contributing water to the Clean and Dirty Dams as well as the Sewage Treatment Plant. The water balance would require the site wide inflows and demands on the

Clean and Dirty Water Dams as well as the Sewage Treatment Plant. As the existing site water balance is still being developed, there was limited information to actually create a complete water balance. As such only the contributions to the Dams and Sewage Treatment Plant were calculated and will be sufficient for incorporation into the site wide water balance once it is completed.

Monthly rainfall data (38 year record) was obtained from the nearest rainfall station (Ellisras, 0674400_W). The rainfall was statically analyzed to obtain the following rainfall scenarios as shown in Table 17.

Table 17: Monthly rainfall scenarios

Rainfall Scenarios	Monthly Rainfall (mm)											
	Oct	Nov	Dec	Jan	Feb	Mar	Apr	May	Jun	Jul	Aug	Sep
Average	31	68	88	78	84	53	38	8	3	1	2	7
Wet Year (80 th Percentile)	39	85	110	98	105	66	48	10	4	1	3	8
Dry Year (20 th Percentile)	22	49	64	56	60	38	28	6	2	1	1	5
Wettest Year on Record	61	132	172	152	164	103	75	15	6	2	4	13
Driest Year on Record	15	33	43	38	41	26	19	4	1	0	1	3

The rainfall depths were then used in conjunction with the FGD catchment areas and calculated runoff coefficients obtained from the rational method (Section 5.2). The clean surface water runoff contributions to the Clean Water dam are shown in Figure 15. The dirty surface water runoff contributions to the Dirty Water dam are shown in Figure 16.

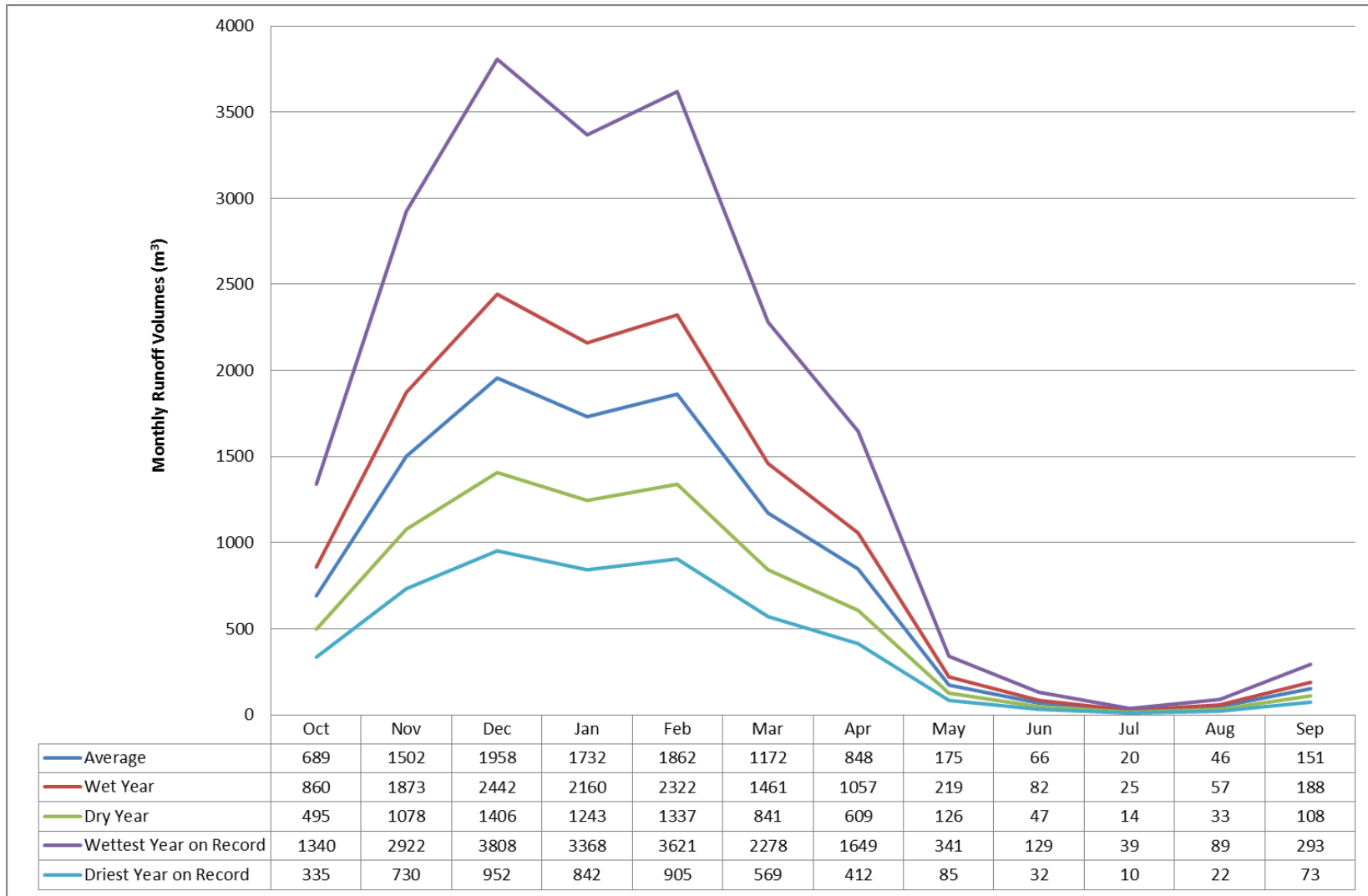

Figure 15: Clean surface water runoff contributions to the Clean Water dam

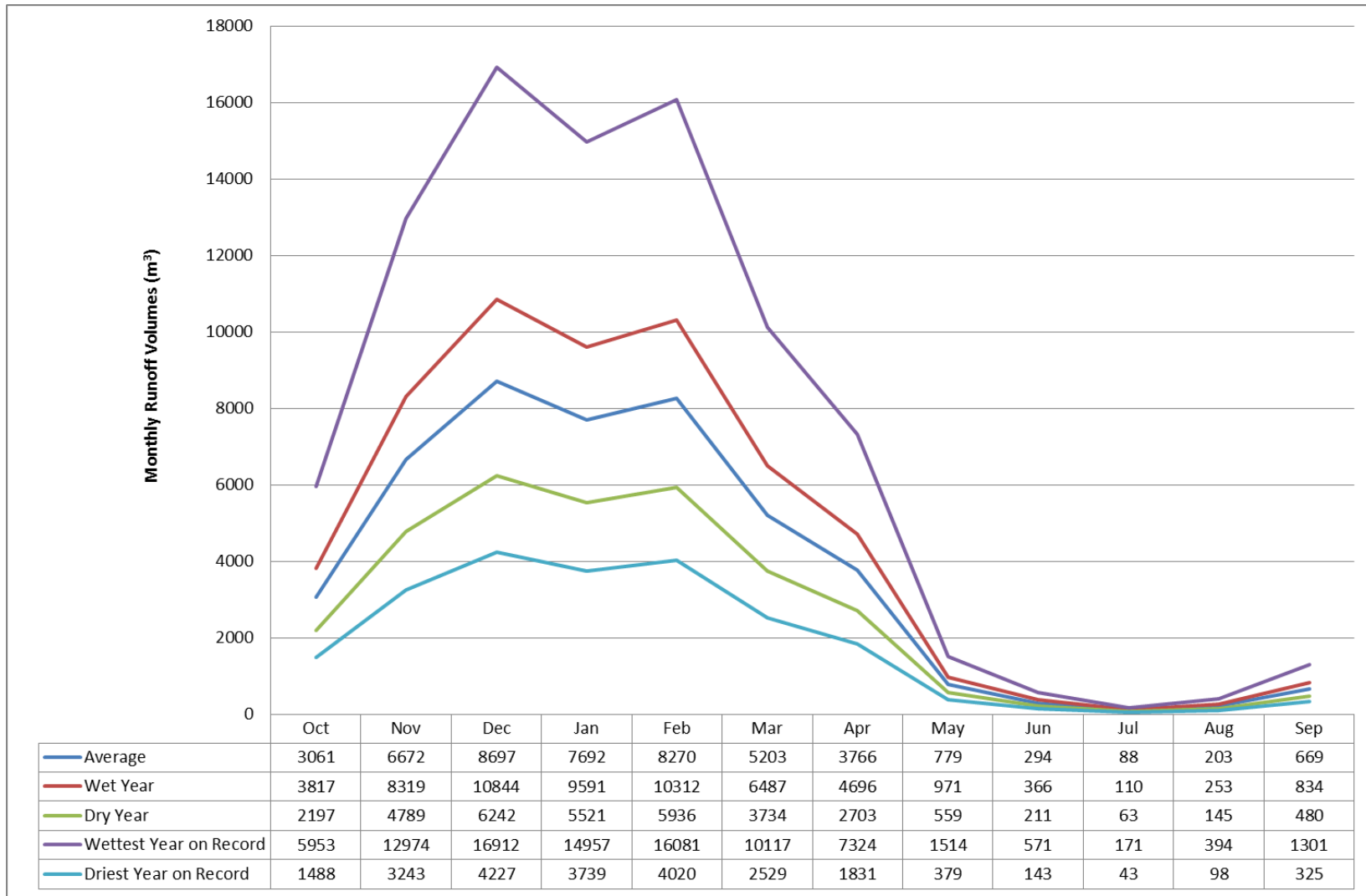

Figure 16: The dirty surface water runoff contributions to the Dirty Water dam

The sewer water contributions to the Sewage Treatment plant are shown in Table 18 below. The safety shower was conservatively assumed to be used once a month per year. The safety shower is assumed to run for 15 min at a time.

Table 18: Sewer water contributions to the Sewage Treatment Plant

Building	Infrastructure	Post-development Peak Flow Rate (l/s)	Sewer Water Contributions per year (m3/annum)
FGD Makeup Water Pre-treatment Building	2x Safety Showers (1 located within the building and one outside)	2.52	27
FGD Common Pump Building	1x Safety Shower	1.26	14
ZLD Building	3x Safety Shower and Ablutions	3.78	41
		0.02	657

9 TRUCK LOADING FACILITY SLAB FOR IMMEDIATE GYPSUM OFFTAKE

9.1 Pavement Design- Structural Capacity Estimation

South African Pavement Engineering Manual (SAPEM), SANRAL, 2014, was used to design the concrete slab as a concrete pavement to accommodate the movement of the trucks on the surface. Method M10 specifically was used. Manual M10 was developed from the AASHTO method for concrete pavements (M10, 1995). The AASHTO method essentially follows a recipe type approach to design and uses a series of nomograms, based on mechanistic design (AASHTO, 1993). For Manual M10, the AASHTO method was refined, validated and simplified for South African conditions.

Manual M10 essentially follows this sequence for designing concrete pavements:

- Determine axle group loading;
- Select stiffness moduli used for slab support layers;
- Use nomograph to get equivalent support stiffness;
- Use nomograph to determine relative vertical movement at joint/crack, i.e., load transfer;
- Use nomograph to obtain slab thickness.

The pavement design is based on a combination and design comparison of the TRH 4 Catalogue design guidelines, the SAPEM M10 Manual, and the South African Mechanistic Design Method (SAMDM), in order to meet the requirement suitable for medium volume traffic and heavy loading.

The assumptions and results from the M10 method are shown in Table 19 below. The results indicate that a minimum structural pavement thickness of 150mm is sufficient. However based on experience on similar applications, a pavement layer of 180 to 200mm is recommended.

Table 19: Assumptions and results from the M10 pavement design method

Axle group loading	E80 Heavy Vehicle
	Vehicle Type: WB-67D (Double Bottom-Semitrailer/Trailer)
	Load: 80kN
Selected stiffness moduli used for support layers	Cement Subbase: 8000MPa
	G7 Subbase: 100MPa
Equivalent support stiffness	110MPa (using subbase thickness of 100mm)
Relative vertical movement at joint/crack	Assuming a 2mm Joint Spacing, 19mm Aggregate Size
	Relative vertical movement: 0.04mm
Slab thickness	Assuming 1×10^6 load repetitions
	Assuming a concrete flexural strength of 3MPa
	Min required slab thickness: 150mm

9.2 Liner Design for the Dirty Area

The concrete slab below the transfer house will be exposed to the gypsum while the trucks are loaded and as a result the slab requires an appropriate liner system so as to minimise the potential contamination or spillage to its surroundings. The management of waste in South Africa is governed under the National Environmental Management: Waste Act, Act 59 of 2008, as amended (NEMWA). On 23 August 2013 the “Norms and Standards for the Assessment of Waste for Landfill Disposal” (National Norms and Standards) were promulgated in the form of

Government Notice Regulations (GNR) 635 (DEA, 2013a). These regulations are used to assess the potential impacts that a waste may have on the receiving water environment and the outcome of the assessment is used to determine the barrier (liner) system required for the waste disposal facility. The barrier systems are prescribed in GNR 636 of August 2013, the “National Norms and Standards for Disposal of Waste to Landfill” (DEA, 2013b).

Jones & Wagener (Pty) Ltd (J&W) undertook the waste assessments for the disposal of the FGD wastes and the power station ash (Waste Assessment of Ash and Flue Gas Desulphurisation Wastes for the Medupi Power Station (Jones& Wagener, 2015)) in order to determine the class of landfill the wastes require disposal onto. The gypsum was assessed as Type 3 waste and can be disposed of on a disposal facility of which the performance of the barrier system complies with that of a Class C landfill. These wastes would produce neutral to alkaline leachate and are chemically and biologically stable and compatible.

The Class C landfill barrier system is presented in Figure 17. This type of landfill is required for the disposal Type 3 wastes to landfill and also consists of a one single composite barrier system. In this case the clay component of the barrier system is 300 mm thick. A Class C barrier is recommended with the exception of replacing the 300mm clay layer with a GCL (X1000). This was done to increase the stability.

Therefore the barrier will consist of a 200mm thick reinforced concrete slab for protection against mechanical damage, 75mm blinding layer, an A6 geotextile to protect the liner, 1.5mm thick HDPE geomembrane as the primary barrier, Geosynthetic Clay Liner (GCL X1000) to provide a secondary impervious barrier, a 150mm soil layer of residual granite, a grid drainage system to relieve the structure from uplift pressures and a compacted pioneer foundation layer comprising of selected dolerite to create a stable working platform.

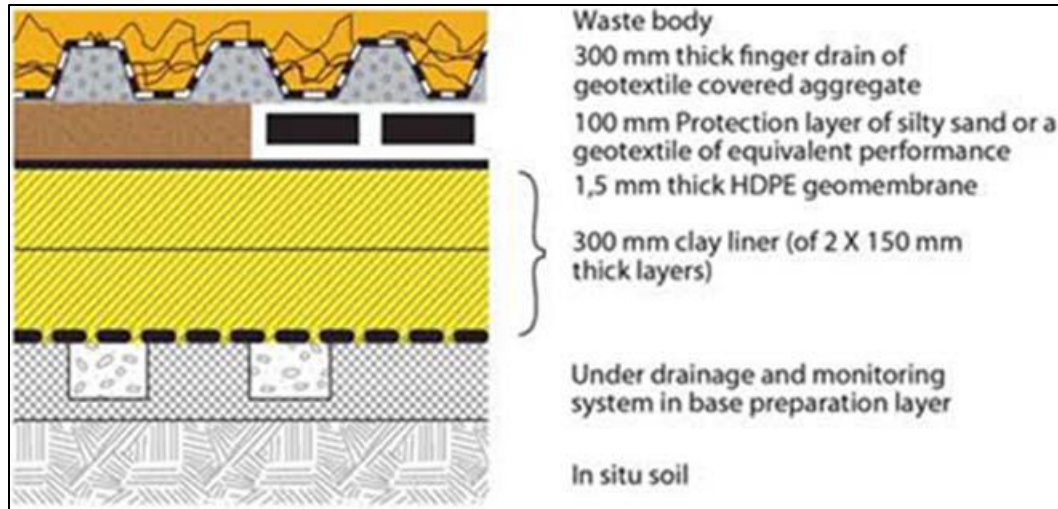

Figure 17: Class C Landfill Barrier System (DEA, 2013b)

9.3 Service life considerations for HDPE Liner

This section discusses the service life considerations of the HDPE liner beyond the closure of the power plant. The integrity, durability and service life of containment barrier systems are affected by exposure and temperature changes.

“The half-life of covered HDPE geomembranes (formulated according to the current GRI-GM13 Specification) is estimated to be 449-years at 20°C.” as published in GRI White Paper 6 on Geomembrane Lifetime Prediction: Unexposed and Exposed Conditions. As the HDPE liner is covered (unexposed) with a 200mm concrete slab, it will not be exposed to UV radiation and the temperature changes will be moderated.

9.4 Recommended Quality Control of the Liner system During Construction

Quality control and assurance during construction of the containment liner are essential to ensure satisfactory installation of this barrier system. Earthworks must be of a high standard to ensure a smooth finish without sharp projections that will damage and prevent intimate contact with the HDPE liner, and compaction must be consistent to prevent differential settlement over the entire project area that could result in rupture of the liner.

Installation of the HDPE liner must comply with SANS 10409: 2005. The liner installation must be supervised and signed off by a Pr.Eng. The installation of all critical items must be witnessed at defined hold points. The hold points shall be:

- Final excavation level for embankment foundation;
- Final earthwork levels;
- QA on layerwork densities to be confirmed before liner installation;
- QA procedures for liner installation to be approved before liner installation;
- Earthworks finish to be inspected and approved before liner installation;
- Installation records to be approved before final acceptance.

9.5 Leakage through the Composite Liner System

Short term leakage through a composite liner system is mainly due to defects which may occur during the installation and operation of the liner, in the form of punctures and seam imperfections.

The leakage rate through the Gypsum Loading Platform liner is controlled by the number and size of defects, pond depth and permeability of the material underlying the plastic liner. The Geosynthetic Research Institute (GRI) considers a leakage rate of between 0.2 and 20 litres/hectare/day as representing a perfect liner. Therefore, an acceptable leakage rate (ALR) of 10 l/ha/day was considered acceptable for the construction of the Gypsum Loading Area. The Gypsum Loading Platform is 670m², which would result in an ALR of 0.7l/day.

The ALR of 10 l/ha/day is considered to be conservative, as the loading bay will in fact be empty for most of the time and the hydraulic gradient will even in the worst storm condition never exceed 300mm. It is therefore anticipated that the leakage will be very close to zero.

10 ACCESS ROADS

10.1 Traffic Management Plan

A logistics / transportation study has been carried out taking into consideration the expected traffic, traffic loading and frequency, whilst conforming to the requirements set out in the Terms of Reference. Traffic Management is attached under separate cover. Refer Appendix C.

10.2 Access Roads Design

The area under consideration is located on the main terrace. The ground slopes on the main terrace are in the order of 0.5% (1:200 fall) sloping away from a level power island. The design of the terrace was largely influenced by the natural topography, the need to contain all stormwater runoff from the terrace area and the general layout of the power station.

The existing roads on the terrace were designed to follow the surface of the terrace such that the upstream kerb side is slightly below the terrace level in order to intersect surface stormwater runoff from the terrace and infrastructure thereon. All roads on the terrace have mountable kerbs on both sides to protect the road edge and to convey the stormwater runoff collected in the roadway to the nearest stormwater kerb inlet and underground stormwater drainage reticulation. Mountable kerbing was chosen to enable construction traffic to access the building sites at any point adjacent to the road and to protect the road edge.

In accordance with the Traffic Management Plan and Eskom requirements, it is envisaged that gypsum trucks shall make use of Medupi's Gate 4 to access the gypsum offloading facility. Vehicles will enter through Gate 4, and then proceed either:

- in a southerly direction along Road 4, onto Road 3 to the gypsum loading platform, or
- in a southerly direction along Road 4, then westerly on Road 27, southerly onto Road 28, before heading north onto Road 3 up to the gypsum loading platform.

Vehicles will exit Medupi by following the reverse of the routes above. If the rail siding is implemented, then Road 28 will be cut-off and vehicular traffic will revert to using Road 3.

10.2.1 Geometric design

The retrofit of the loading platform follows the same design approach applied for the original terrace roads. The geometric design standard complies with the requirements of *UTG10: Guidelines for the Geometric Design of Commercial and Industrial Streets*. The road layouts/configuration is in accordance with Eskom's requirements.

The gypsum loading platform has been designed to accommodate the WB-67D Design Vehicle, typical of conventional bulk side-tipper trucks. Vehicle size and manoeuvrability were considered and simulated using AutoTurn design software. Based on the turning configurations, the optimal loading platform layout was achieved.

The WB-67D Design Vehicle is shown in Figure 18 below.

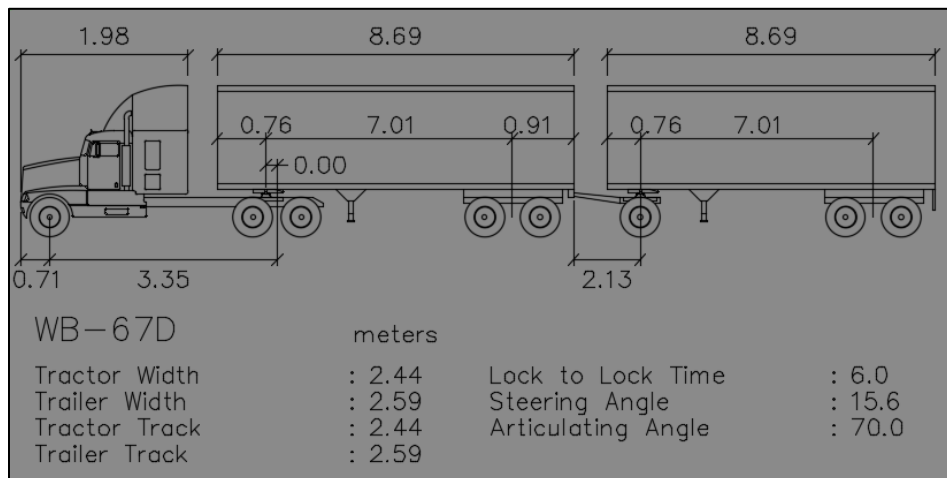

Figure 18: Design Vehicle WB-67D

Various vehicle turning movements were simulated to ensure that the vehicle could access the gypsum turning platform from all possible directions, including:

- Turning Movement 1:
 - Southbound on Road 3 from Gate 4
 - Turn left (east) onto the loading platform
 - Load
 - Exit northbound on Road 3 to Gate 4
- Turning Movement 2:
 - Southbound on Road 3 from Gate 4

- Turn left (east) onto the loading platform
 - Load
 - Exit southbound on Road 3
 - Proceed to Road 28 / 27 to Gate 4
- Turning Movement 3:
 - Northbound on Road 3 from Gate 4 via Road 27 / 28
 - Turn right (east) onto the loading platform
 - Load
 - Exit southbound on Road 3
 - Proceed to Road 28 / 27 to Gate 4
- Turning Movement 4:
 - Northbound on Road 3 from Gate 4 via Road 27 / 28
 - Turn right (east) onto the loading platform
 - Load
 - Exit northbound on Road 3 to Gate 4

The 4 possible turning movements are shown in Figure 19.

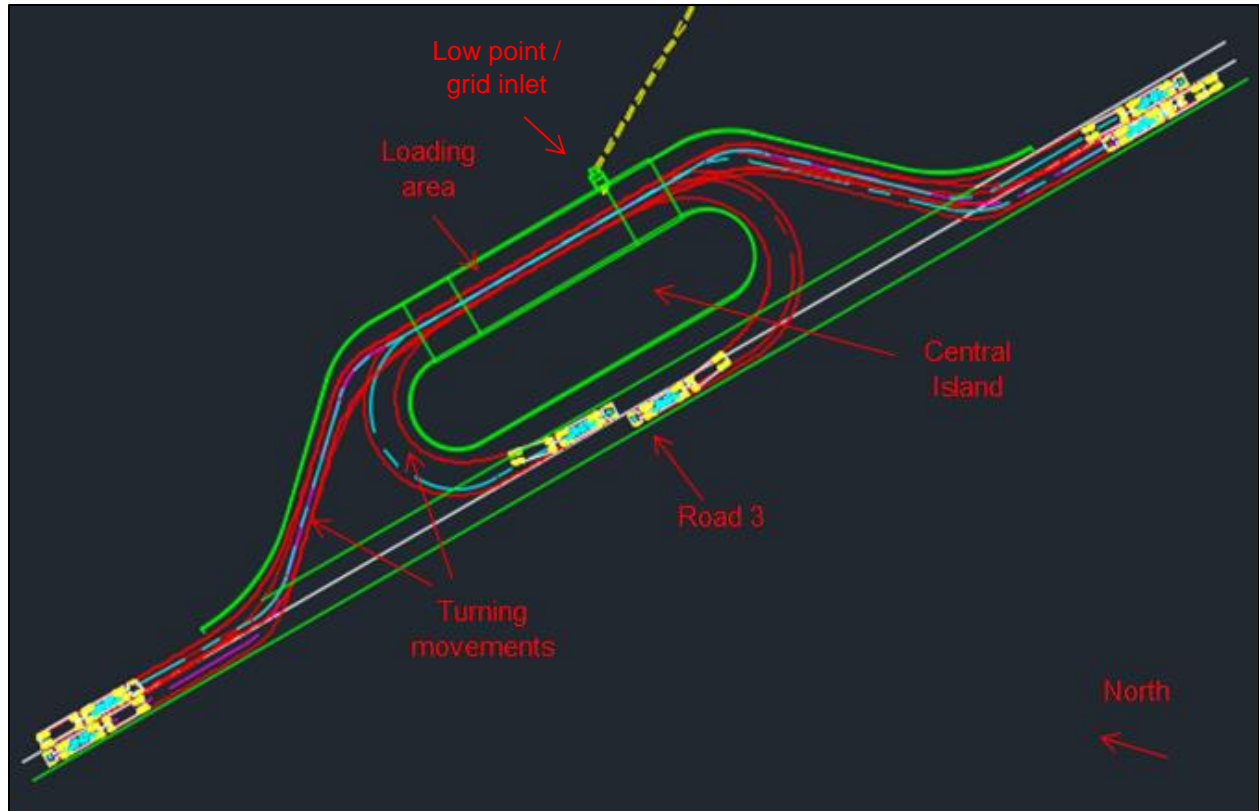

Figure 19: Design Vehicle WB-67D: possible vehicle turning movements

The platform's approach and departure kerblines (35m radii) facilitate safe entry and exit to the platform from Road 3. The central island's radii allow safe turning of the large vehicles. The platform footprint has a surface area of approximately 4,400m², of which 3,100m² is concrete paved and 1,300m² is shaped natural ground.

The layout of the platform facilitates a concrete paved temporary vehicle staging area approximately 5m wide, spanning the length of its interface with Road 3. The gypsum loading area is effectively 84m long by 12,2m wide which allows for stacking of trucks as well as a vehicle bypass or additional staging area. The staging and bypass areas will assist with traffic management during plant down time and or vehicle breakdowns.

The number of trucks stacking is a function of the supply/demand for the gypsum by-product and the probability and duration of plant breakdowns. Effectively 4 trucks per line (2 lines) at the

loading platform and approximately 6 per line (2 lines) adjacent to Road 3, can be accommodated. Additional staging areas are located along Roads 3, 27 and 28.

The total gypsum truck queue length that needs to be accommodated during the downtime is 225m (9 vehicles). The traffic requirements are included the Traffic Management Plan, in Appendix C.

The platform is enclosed by mountable kerbs on its perimeter, tying into the existing kerbing along Road 3. Road 3 and the platform will be separated by either a mountable kerb positioned at a very flat angle, or by a shaped edge beam – this to separate the drainage between the two. Due to the level difference between the central island and the lowered loading bay, a special, deeper kerb is proposed, to assist with containing spillage.

The platform slopes in a south-easterly direction at 0,5% from its northern entry point towards south-eastern corner of the loading area. As the platform enters the lowered loading area, it slopes down at 3% to the loading area base. The loading area base slopes at 1,5% down to the lowest point of the loading area, to tie in to a dirty water stormwater grid inlet. From the southern entry point, the platform gradually slopes down towards the loading area. On entry into the loading area it lowers at a rate of 3% to the loading area base. The natural ground central island is shaped to facilitate natural drainage to an existing stormwater system.

The loading area has been designed lower than the surrounding platform in order to contain any spillage due to loading and to prevent contamination outside of the loading platform. The loading area has an area of approximately 670m².

The loading platform contour detail is shown in Figure 20.

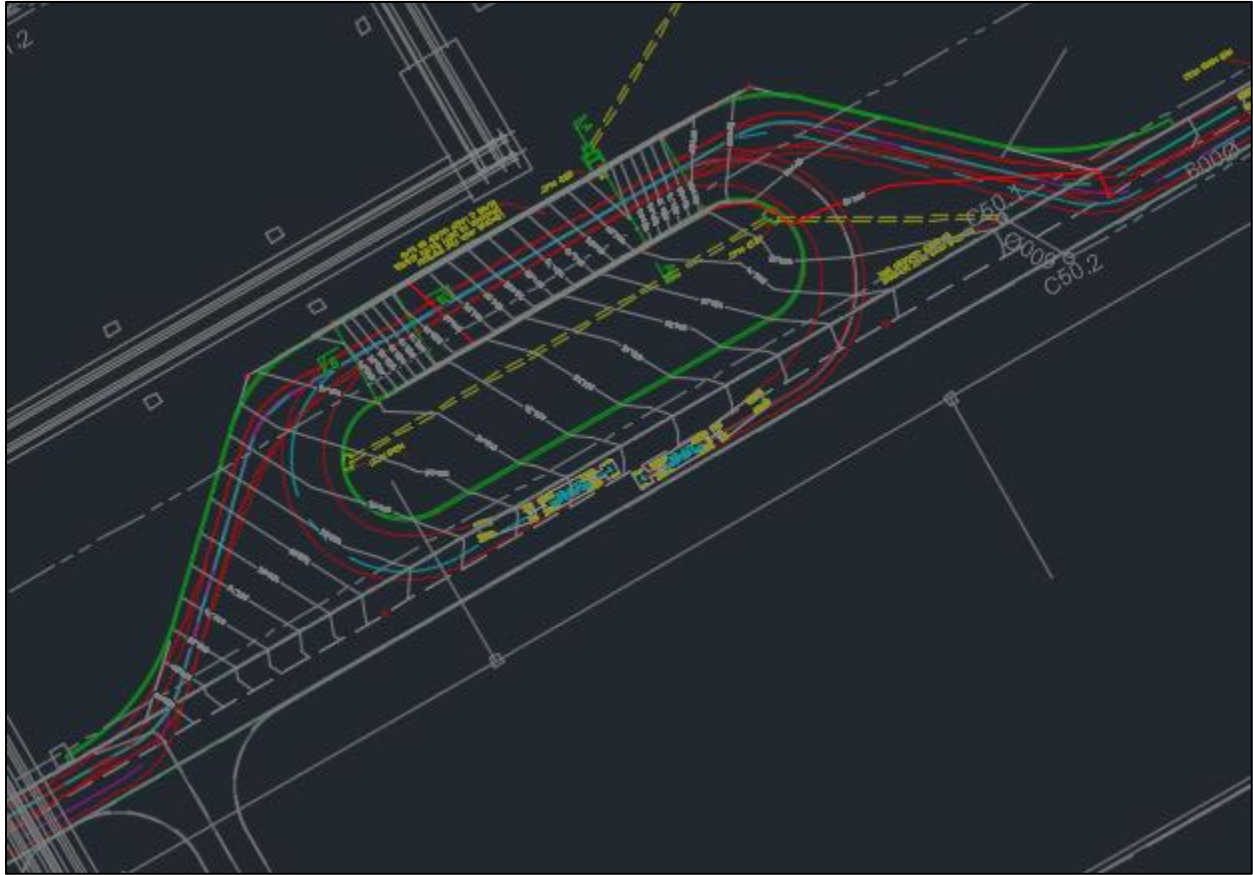
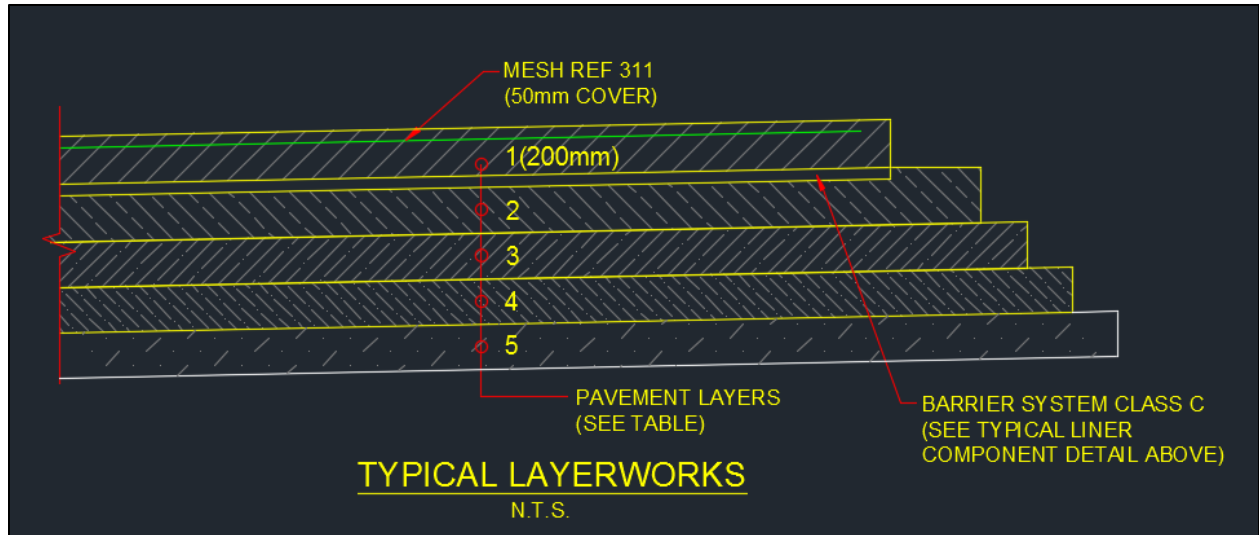

Figure 20: Gypsum loading platform contour detail

10.2.2 Pavement design

Considering the envisaged local road building materials available and expected traffic, as well as the environmental requirements for containing hazardous materials (gypsum), the preferred and recommended pavement structure for the loading platform is a concrete base and stabilised subbase configuration. The proposed pavement structure is indicated in Figure 21 below.



PAVEMENT LAYER	DESCRIPTION
1	180mm/200mm JPCP CONCRETE SLAB (35MPa/19mm) WITH MESH / DOWLES AND TIE BARS AS DETAILED (MIN 50mm COVER)
2	200mm C3 CEMENTED SUB-BASE LAYER COMPACTED TO 95% MODIFIED AASHTO DENSITY
3	150mm G7 NATURAL GRAVEL OR IN-SITU SUBGRADE UPPER SELECTED COMPACTED TO 95% MODIFIED AASHTO DENSITY
4	150mm G9 NATURAL GRAVEL OR IN-SITU SUBGRADE, LOWER SELECTED COMPACTED TO 93% MODIFIED AASHTO DENSITY
5	150mm G10 ROADBED OR IN-SITU SUBGRADE, RIP AND RE-COMPACT TO 90% MODIFIED AASHTO DENSITY

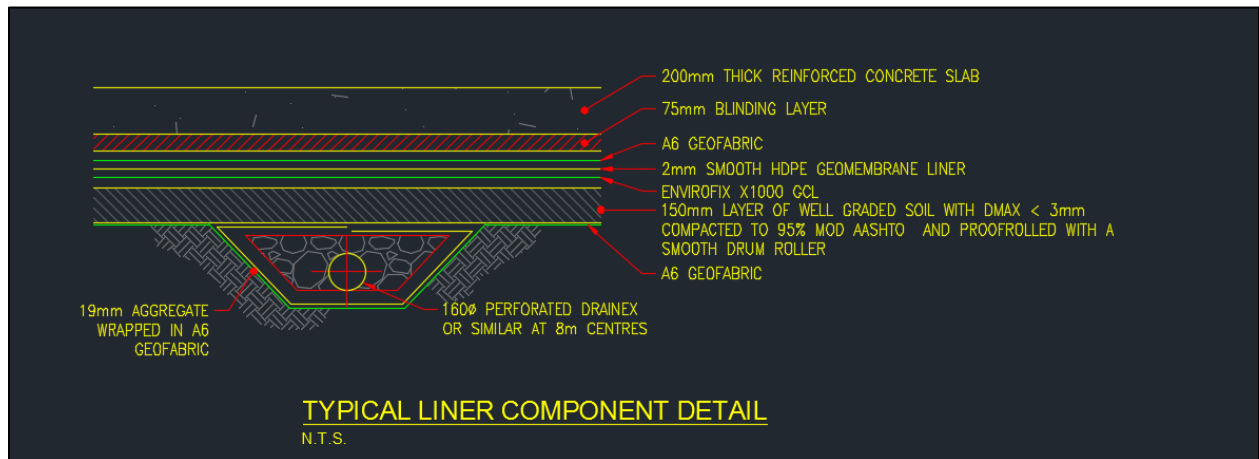

Figure 21: Proposed pavement structure

The pavement design is based on a combination and design comparison of the TRH 4 Catalogue design guidelines and a mechanistic design and the SAPEM M10 Manual, in order to meet the requirement suitable for medium volume traffic and heavy loading.

It is recommended that the concrete base slab be set out as a series of smaller panels in the order of 3,5-4m long by 3-3,5m wide in order to reduce the effect of shrinkage. The panels to receive combinations of transverse dowelled and undowelled contraction joints (saw cut) and longitudinal key joints, with isolation joints on free ends or wall interfaces, as applicable.

A typical longitudinal and transverse joint layout plan that can be configured to suite the loading platform is shown in Figure 22 below.

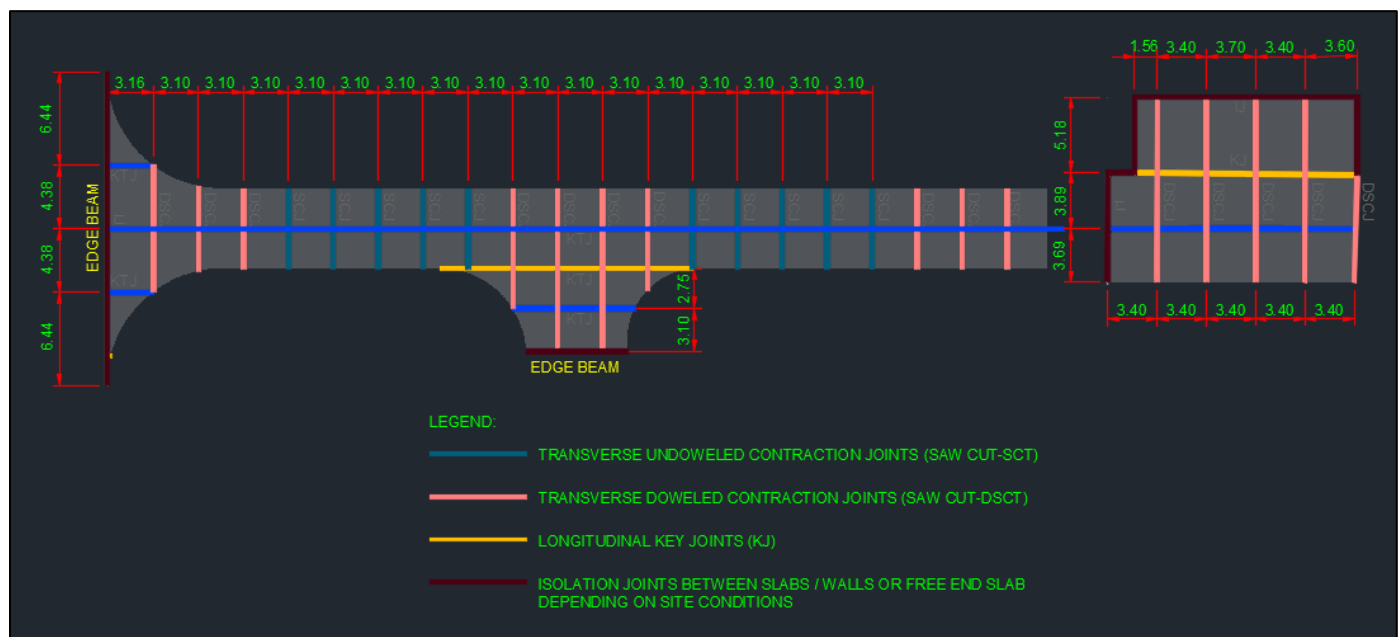

Figure 22: Typical longitudinal and transverse joint layout plan

10.3 Construction Cost Estimate

The estimated cost to construct the gypsum off-take loading platform (3 100 m² concrete-surfaced area) is summarised as follows in Table 20:

Table 20: Construction cost estimate

Item No.	Description	Unit	Quantity	Rate	Amount	Note
1	Cut to spoil	m ³	1705	R 50	R 85 250.00	*
2	150mm G10 Roadbed or in-situ subgrade, rip and recompact to 90% Mod.AASHTO density	m ³	465	R 40	R 18 600.00	**
3	150mm G9 natural gravel or in-situ subgrade, lower selected compacted to 93% Mod.AASHTO density	m ³	465	R 40	R 18 600.00	**
4	150mm G7 natural gravel or in-situ subgrade, upper selected compacted to 95% Mod.AASHTO density	m ³	465	R 80	R 37 200.00	
5	200mm C3 cemented subbase layer compacted to 95% Mod.AASHTO density	m ³	620	R 120	R 74 400.00	***
6	E/O stabilisation	m ³	620	R 25	R 15 500.00	
7	Cement	t	43	R 1 800	R 77 400.00	
8	180/200mm JPCP concrete slab (35MPa/19mm) including Ref.311 top mesh / dowels and tie-bars as detailed, and liner	m ³	558	R 2 500	R 1 395 000.00	
9	Kerbing, mountable	m ³	540	R 200.0	R 108 000.00	
10	SUB-TOTAL A				R 1 829 950.00	
	Preliminary and General (% of sub-total A)	%		30%	R 548 985.00	
11	SUB-TOTAL B				R 2 378 935.00	
	Contingencies (% of sub-total B)	%		30%	R 713 680.50	
12	SUB-TOTAL C				R 3 092 615.50	

	Planning design and supervision (% of sub-total C)	%		10%	R 309 261.55
	SUB-TOTAL D				R 3 401 877.05
13	VAT (% of sub-total D)	%		14%	R 476 262.79
	TOTAL PROJECT COST				R 3 878 139.84

Note:

- * Excavation cut to spoil up to top of lower selected layer, i.e. in-situ material to be used for lowest layers
- ** Use in-situ material, i.e. processing cost only
- *** Locally sourced parent material

11 CONCLUSIONS

11.1 Stormwater Management

The post-development catchment delineation was undertaken based on the existing and proposed FGD main area infrastructure, the proposed WWTP and a temporary waste handling facility with some storage capacity. The stormwater management in this area is required to cater for the potential spillages which may occur during transportation of the chemical salts and sludge.

Based on the considerations above two alternative stormwater management approaches may be adopted:

- Alternative 1: Catchment 1 and 5 were re-designated to dirty water catchments so as to contain any potential spillages which may occur during transportation of the chemical salts and sludge. The remaining catchment designations remain the same as the pre-development scenario. This updated scenario was termed the post development scenario for Alternative 1.
- Alternative 2: Catchment 1 and 5 remain as clean water catchments and it is assumed that the proposed WWTP will be maintained as a bunded system and therefore be isolated. Where the potential spillages are kept within the WWTP footprint, this would negate the need to re-designate the catchments. This updated scenario was termed the post-development scenario for Alternative 2.

The post-development peak flows were then calculated (using the rational method) by updating the percentage impervious areas and designation for each of the catchments based on the existing and proposed FGD main area infrastructure for Alternative 1 and 2 stormwater management approaches..

11.1.1 Alternative 1

The results indicate that the post-development flood peaks are less than the pre-development flood peaks; this was due to the conservative approach adopted in the pre-development scenario as more development of the catchment was anticipated. This was done to allow for substantial development within the terrace area without having to increase the stormwater system capacity once the final infrastructure layout is developed. The results show that

approximately 35% of the total conveyance capacity is utilized. However based on the re-designation of catchment 1 and 5 was re-designated to dirty water catchments the runoff generated from these catchments will have to be conveyed to the Dirty Water Dam. This will be done by using the existing clean water infrastructure (kerb inlets and pipelines) to collect runoff directly from the catchment and then one of two approaches can be adopted:

- Option 1: The existing clean water pipeline is connected into the dirty water pipeline. The existing dirty water pipelines were then evaluated to determine if they have sufficient capacity to convey the re-designated catchment peak flows. It was found that there is insufficient capacity to tie into the existing dirty water system.
- Option 2: The existing clean water pipeline is converted into dirty water line and extended via a new pipeline 1.2 m in diameter (1.4 km long) which will convey the dirty water to Dirty Water Dam directly.

Due to the findings mentioned above option 2 is recommended. Based on the re-designation of the catchments areas, 20% of the total dirty water catchment areas will now be added to the dirty water system. It is therefore anticipated that the existing Dirty Water Dam (102 00 m³ capacity) will have insufficient capacity to store the new dirty water runoff volumes. Additional dirty water storage will be required. This has not been sized as it is not part of the scope. The Dirty Water Dam capacity would have to be validated using a water balance so as to take into account the demands on the Dam. The 9% reduction in clean water areas indicates that the Clean Water Dam (133 400 m³ capacity) will have sufficient capacity to cope with the proposed FGD infrastructure.

11.1.2 Alternative 2

The results indicate that the post-development flood peaks are less than the pre-development flood peaks; this was due to the conservative approach adopted in the pre-development scenario as more development of the catchment was anticipated. This was done to allow for substantial development within the terrace area without having to increase the stormwater system capacity once the final infrastructure layout is developed. The results show that approximately 35% of the total conveyance capacity is utilized. The reduction in flood peaks indicates that the Clean and Dirty Water Dams (102 00 m³ capacity for the Dirty Water Dam and 133 400 m³ capacity for the Clean Water Dam) have sufficient capacity to cope with the proposed FGD infrastructure.

It is therefore recommended that Alternative 1 be implemented so as to account for the potential spillages which may occur during transportation of the chemical salts and sludge from the WWTP to the storage areas. Option 2 (of Alternative 1) is recommended as the existing dirty water pipeline infrastructure has inadequate capacity to carry the proposed additional flow necessitating an additional pipeline.

11.2 Sewage Infrastructure Design

The pre-development and post-development sewage peak flows were calculated and compared. It was found that the existing sewage network is capable of conveying the post-development peak flows. This result indicates that the existing Sewage Treatment Plant capacity is capable of accommodating the additional flows. The proposed connection points were identified as MH152 (FGD Make-up Water Pre-treatment Building) and MH89 (FGD Common Pump Building and ZLD Building). The sewage pipelines were designed to take the peak flows obtained from SANS 10400 Part P – Drainage and the Spraydench Emergency Showers Suppliers.

11.3 Water Balance

As the FGD area is only contributing water to the Clean and Dirty Dams as well as the Sewage Treatment Plant. The water balance would require the site wide inflows and demands on the Clean and Dirty Water Dams as well as the Sewage Treatment Plant. As the existing site water balance is still being developed, there was limited information to actually create a complete water balance. As such only the contributions to the Dams and Sewage Treatment Plant were calculated (Alternative 1, Option 2 scenario) and will be sufficient for incorporation into the site wide water balance once it is completed.

11.4 Truck Loading Facility Slab for the Immediate Gypsum Offtake

11.4.1 Pavement Design- Structural Capacity Estimation

The pavement design was based on a combination and design comparison of the TRH 4 Catalogue design guidelines, the SAPEM M10 Manual, and the South African Mechanistic Design Method (SAMDM), in order to meet the requirement suitable for medium volume traffic and heavy loading. The results indicate that a minimum structural pavement thickness of

150mm is sufficient. However based on experience on similar applications, a pavement layer of 180 to 200mm is recommended.

11.4.2 Liner Design for the Dirty Area

The gypsum was assessed as Type 3 waste and can be disposed of on a disposal facility of which the performance of the barrier system complies with that of a Class C landfill. This type of landfill consists of a one single composite barrier system. In this case the clay component of the barrier system is 300 mm thick. A Class C barrier is recommended with the exception of replacing the 300mm clay layer with a GCL (X1000). This was done to increase the stability.

Therefore the barrier will consist of a 200mm thick reinforced concrete slab for protection against mechanical damage, 75mm blinding layer, an A6 geotextile to protect the liner, 1.5mm thick HDPE geomembrane as the primary barrier, Geosynthetic Clay Liner (GCL X1000) to provide a secondary impervious barrier, a 150mm soil layer of residual granite, a grid drainage system to relieve the structure from uplift pressures and a compacted pioneer foundation layer comprising of selected dolerite to create a stable working platform.

11.5 Access Roads Design

11.5.1 Traffic Management Plan

A logistics / transportation study has been carried out taking into consideration the expected traffic, traffic loading and frequency, whilst conforming to the requirements set out in the Terms of Reference.

11.5.2 Access roads design

The retrofit of the access follows the same design approach applied for the original terrace roads. The geometric design standard complies with the requirements of UTG10 : Guidelines for the Geometric Design of Commercial and Industrial streets. The road layouts/configuration is in accordance with Eskom's requirements.

The gypsum loading platform has been designed to accommodate the WB-67D Design Vehicle, typical of conventional bulk side-tipper trucks. Various vehicle turning movements were

simulated to ensure that the vehicle could access the gypsum turning platform from all possible directions. The layout of the platform facilitates a concrete paved temporary vehicle staging area approximately 5m wide, spanning the length of its interface with Road 3. The gypsum loading area is effectively 84m long by 12,2m wide which allows for stacking of trucks as well as a vehicle bypass or additional staging area. The staging and bypass areas will assist with traffic management during plant down time and or vehicle breakdowns.

Considering the envisaged local road building materials available and expected traffic, the recommended pavement structure for the loading platform is a concrete base and stabilised subbase configuration.

12 RECOMMENDATIONS

The following recommendations were made:

- A site-wide water balance should be developed to aid in the capacity assessment of the Clean and Dirty Water Dams should Alternative 1, Option 2 be implemented.
- A survey is undertaken on all proposed routes for new sewers or stormwater pipes using Ground Penetrating Radar (GPR) before any excavation occurs to check for existing services.
- Eskom obtains approval from Department of Environmental Affairs (DEA) and the Department of Water and Sanitation (DWS).
- After approvals have been obtained a Tender Design and Specification be developed based on the conceptual design.

13 REFERENCES

Department of Environmental Affairs, 2013a. National norms and standards for the assessment of waste for landfill disposal. R635 of 23 August 2013, Government, Gazette 36784 of 23 August 2013, Government Printer, Pretoria.

Department of Environmental Affairs, 2013b. National norms and standards for disposal of waste to landfill. R636 of 23 August 2013, Government Gazette 36784 of 23 August 2013, Government Printer, Pretoria.

Guidelines for Human Settlement Planning and Design Compiled under the Patronage of the Department of Housing by the CSIR Building and Construction Technology ISBN 0-7988-5498-7

The Manual on the Design of Small Sewage Works First Ed 1988. The Water Institute of South Africa. ISBN 0-620-11110-0

General Notice 704 (GN 704) and Regulation 77 of the South African National Water Act, 1998. (Act No. 36 of 1998. Department of Water and Sanitation.

Department of Transport. First Edition 1990. GUIDELINES FOR THE GEOMETRIC DESIGN OF COMMERCIAL AND INDUSTRIAL LOCAL STREETS (DRAFT UTG 10).

Committee of State Road Authorities. 1981. TMH7: Code of Practice for the design of highway bridges and culverts in South Africa. Parts 1,2 and 3.

The South African National roads Agency. 2014. South African Pavement Engineering manual.

Appendix A:

RATIONAL METHOD (ALTERNATIVE 2) - Bare Area			
Size of Catchment, A (km ²)	0.001	Mean Annual Rainfall (mm)	465.00
Longest Watercourse, L (km)	0.072	Time of Concentration, tc (hours)	0.21
Average Slope, S _{av} (m/m)	0.005	2-year return period daily rainfall, M (mm)	54.90
Combined run-off coefficient, C _r	0.348	Days of Thunder per year, R (days/year)	50
r	0.1		

Return Period	Point Rainfall (mm)	Average Intensity (mm/hr)	Peak flow (m ³ /s)	Peak flow (l/s)
2	15.10	72.65	0.01	9.21
5	25.47	122.56	0.02	15.54
10	33.32	160.31	0.02	20.33
20	41.16	198.06	0.03	25.12
50	51.54	247.97	0.03	31.45
100	59.38	285.73	0.04	36.24
200	67.23	323.48	0.04	41.03

Rural				
Surface slope	%	Factor	Cs	
Wetlands and pans (<3%)	100.00	0.01	0.01	
Flat Areas (3 to 10%)			0.06	
Hilly (10 to 30%)		0.12		
Steep Areas (>30%)		0.22		
Total Check	100.00			
Total	100	-	0.01	
Permeability				
	%	Factor	Cp	
Very permeable		0.03	0	
Permeable	70	0.06	0.042	
Semi-permeable	30	0.12	0.036	
Impermeable		0.21	0	
Total Check	100			
Total	100	-	0.078	
Vegetation				
	%	Factor	Cv	
Thick bush and plantation		0.03	0	
Light bush and farm-lands		0.07	0	
Grasslands		0.17	0	
No vegetation	100	0.26	0.26	
Total Check	100			
Total	100	-	0.26	
Total (C1)			0.348	

Minimum required pipe diameter

$$Q = VA = \left(\frac{1.49}{n}\right) AR^{\frac{2}{3}} \sqrt{S} \quad [\text{U.S.}]$$

$$Q = VA = \left(\frac{1.00}{n}\right) AR^{\frac{2}{3}} \sqrt{S} \quad [\text{SI}]$$

Assuming full pipe flow :

$$A = \frac{\pi D^2}{4}$$

$$R = \frac{A}{P}, \text{ where } P \text{ is the wetted perimeter of the pipe}$$

$$P = 2\pi r = 2\pi \cdot \frac{D}{2}$$

Therefore:

$$R = \frac{\frac{\pi D^2}{4}}{2\pi \cdot \frac{D}{2}} = \frac{D}{4}$$

Hence:

$$Q = \frac{1}{n} \cdot \left(\frac{\pi D^2}{4}\right) \cdot \left(\frac{D}{4}\right)^{\frac{2}{3}} \cdot S^{1/2}$$

Solving for minimum required pipe diameter, D (in mm):

$$D = \sqrt[8]{\left(\frac{Q}{\left(\frac{S^{1/2} \cdot \pi}{n \cdot 4^{5/3}}\right)}\right)^3} \cdot 1000 = 212.43$$

Inputs	
Q (m3/s)	0.03
v (m/s)	0.89
S (m/m)	0.006667
n	0.013

Recommended Pipe	
Use 600mm uPVC pipe	
MAX, 0.8D (l/s)	405.574
MAX, 0.8D (m3/s)	0.405574
v, 0.8 (m/s)	1.92773

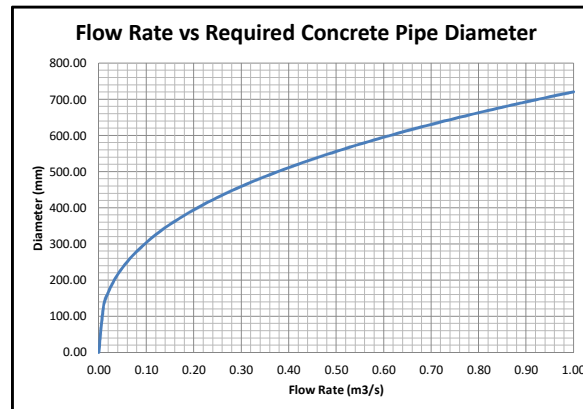

RATIONAL METHOD (ALTERNATIVE 2) - Concrete Slab Area			
Size of Catchment, A (km ²)	0.003	Mean Annual Rainfall (mm)	465.00
Longest Watercourse, L (km)	0.118	Time of Concentration, tc (hours)	0.12
Average Slope, S _{av} (m/m)	0.005	2-year return period daily rainfall, M (mm)	54.90
Combined run-off coefficient, C _r	0.950	Days of Thunder per year, R (days/year)	50
r	0.02		

Return Period	Point Rainfall (mm)	Average Intensity (mm/hr)	Peak flow (m ³ /s)	Peak flow (l/s)
2	11.38	92.20	0.08	75.42
5	19.20	155.53	0.13	127.23
10	25.11	203.45	0.17	166.43
20	31.03	251.36	0.21	205.63
50	38.85	314.70	0.26	257.44
100	44.76	362.61	0.30	296.63
200	50.68	410.52	0.34	335.83

Minimum required pipe diameter

$$Q = VA = \left(\frac{1.49}{n}\right) AR^{\frac{2}{3}} \sqrt{S} \quad [\text{U.S.}]$$

$$Q = VA = \left(\frac{1.00}{n}\right) AR^{\frac{2}{3}} \sqrt{S} \quad [\text{SI}]$$

Assuming full pipe flow :

$$A = \frac{\pi D^2}{4}$$

$$R = \frac{A}{P}, \text{ where } P \text{ is the wetted perimeter of the pipe}$$

$$P = 2\pi r = 2\pi \cdot \frac{D}{2}$$

Therefore:

$$R = \frac{\frac{\pi D^2}{4}}{2\pi \cdot \frac{D}{2}} = \frac{D}{4}$$

Hence:

$$Q = \frac{1}{n} \cdot \left(\frac{\pi D^2}{4}\right) \cdot \left(\frac{D}{4}\right)^{\frac{2}{3}} \cdot S^{\frac{1}{2}}$$

Solving for minimum required pipe diameter, D (in mm):

$$D = \sqrt[8]{\left(\frac{Q}{\left(\frac{S^{1/2} \cdot \pi}{n \cdot 4^{5/3}}\right)}\right)^3} \cdot 1000 = 433.10$$

Inputs	
Q (m ³ /s)	0.26
v (m/s)	1.75
S (m/m)	0.01
n	0.013

Recommended Pipe	
Use 600mm uPVC pipe	
MAX, 0.8D (l/s)	496.725
MAX, 0.8D (m ³ /s)	0.496725
v, 0.8 (m/s)	2.36098

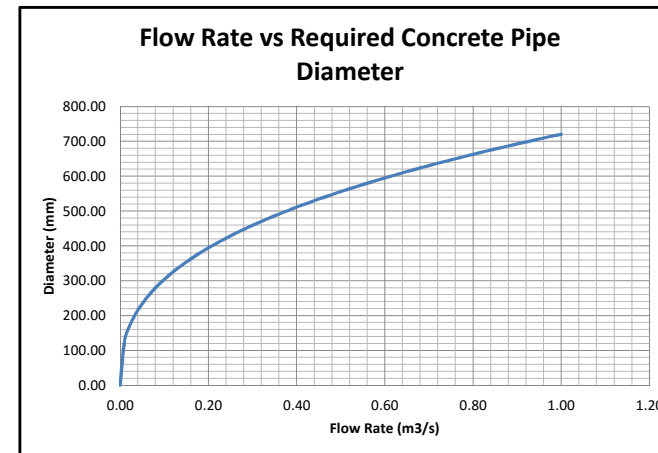

FLOOD FREQUENCY ANALYSIS RATIONAL METHOD (CALCULATION SHEET)

GENERAL DATA		TOPOGRAPHY AND GEOLOGY	
PROJECT NO.		CATCHMENT AREA (km ²)	0.0481
RIVER / AREA No.	1	LONGEST WATER COURSE (km)	0.3
ANALYSIS BY	E.Naidoo	1085 HEIGHT DIFFERENCE (m)	2
DATE		DOLOMITIC AREA (%)	0

AREA WEIGHTING FACTORS %					
URBAN	0	RURAL	100	LAKES	0

MAP (mm)
470

PHYSICAL CHARACTERISTICS AND RECOMMENDED VALUES OF RUNOFF COEFFICIENTS (RURAL)

PHYSICAL CHARACTERISTICS		RECOMM. RUNOFF COEFF. C			'C'	CY
STEEPNESS	% OF AREA	MAP				
		< 600	600-900	>900		
< 3 %	100	0.01	0.03	0.05	0.01	0.010
3 to 10%	0	0.06	0.08	0.11	0.06	0.000
10 to 30%	0	0.12	0.16	0.20	0.12	0.000
30 to 50%	0	0.22	0.26	0.30	0.22	0.000
> 50%	0	0.26	0.30	0.34	0.26	0.000
						CV = 0.010

PHYSICAL CHARACTERISTICS		RECOMM. RUNOFF COEFF. C			'C'	CP
PERMEABILITY	% OF AREA	MAP				
		< 600	600-900	>900		
VERY PERMEABLE	5	0.03	0.04	0.05	0.03	0.002
PERMEABLE	50	0.06	0.08	0.10	0.06	0.030
SEMI-PERMEABLE	40	0.12	0.15	0.20	0.12	0.048
IMPERMEABLE	5	0.21	0.26	0.30	0.21	0.011
						CP = 0.090

PHYSICAL CHARACTERISTICS		RECOMM. RUNOFF COEFF. C			'C'	CV
VEGETATION	% OF AREA	MAP				
		< 600	600-900	>900		
DENSE BUSH, FOREST	0	0.03	0.04	0.05	0.03	0.000
CULTIVATED LAND	0	0.07	0.11	0.15	0.07	0.000
GRASS LAND	20	0.17	0.21	0.25	0.17	0.034
BARE SURFACE	80	0.26	0.28	0.30	0.26	0.208
						CV = 0.242

PHYSICAL CHARACTERISTICS AND RECOMMENDED VALUES OF RUNOFF COEFFICIENTS (URBAN)

PHYSICAL CHARACTERISTICS		RECOMM. RUNOFF COEFF. C			'C'	CV
OCCUPATION	% OF AREA	MAP				
		< 600	600-900	>900		
LAWNS, PARKS						
SANDY, FLAT < 2 %	0.00	0.05	to	0.10	0.08	0.00
SANDY, STEEP > 7 %	0.00	0.15	to	0.20	0.18	0.00
HEAVY SOIL, FLAT < 2 %	0.00	0.13	to	0.17	0.15	0.00
HEAVY SOIL, STEEP < 7 %	0.00	0.25	to	0.35	0.30	0.00
RESIDENTIAL						
SINGLE DWELLING AREA	0.00	0.30	to	0.50	0.40	0.00
FLATS	0.00	0.50	to	0.70	0.60	0.00
INDUSTRIAL						
LIGHT INDUSTRIES	0.00	0.50	to	0.80	0.65	0.00
HEAVY INDUSTRIES	0.00	0.50	to	0.90	0.70	0.00
BUSINESS						
DOWNTOWN	0.00	0.70	to	0.95	0.83	0.00
NEIGHBOURHOOD	0.00	0.50	to	0.70	0.60	0.00
NEIGHBOURHOOD						
STREETS	0.00	0.70	to	0.95	0.83	0.00
						CU = 0.00

RETURN PERIOD ADJUSTMENT FACTOR

RETURN PERIOD	RURAL	URBAN
T (years)	f _r	
2	0.75	For return periods equal or greater than 50 years C _r = 1.00
5	0.80	
10	0.85	
20	0.90	
50	0.95	
100	1.00	
200	1.00	
$C_r = f_r(C_u + C_p + C_v)$		

TIME OF CON. T_c (hr)

$[0.87 \cdot L \wedge (3/H)] \wedge 0.385$
0.40

LIGHTNING DENSITY

4

FRANCOU - RODIER REGIONAL COEFF.

5

RAINFALL

POINT RAINFALL FOR TIME OF CONCENTRATION t _c						
RETURN PERIOD (years)	5	10	20	50	100	200
POINT RAINFALL DEPTH (mm)	23	29	36	47	58	73
POINT INTENSITY (mm/h)	57	73	90	117	144	180
AREA REDUCTION FACTOR %	99	99	98	98	98	97
AVERAGE INTENSITY (mm/h) I _r	57	72	88	114	141	174

AREA WEIGHTED RUNOFF COEFFICIENT

RETURN PERIOD (years)	5	10	20	50	100	200
RURAL	0.27	0.29	0.31	0.32	0.34	0.34
URBAN	0.00	0.00	0.00	0.00	0.00	0.00
LAKES	0.00	0.00	0.00	0.00	0.00	0.00
AREA WEIGHTED AVERAGE C _r	0.27	0.29	0.31	0.32	0.34	0.34

PEAK DISCHARGE (m³ / s)

RETURN PERIOD (years)	5	10	20	50	100	200
Q _T = 0.278 C _r I _r A	0.2082	0.2800	0.3624	0.4972	0.6442	0.7970

RECOMMENDED PROCEDURE

- Locate the site on 1:50 000 or 1:250 000 topographical maps.
- Determine the following catchment characteristics for the site:
 - Demarcate the catchment boundary on the 1:50 000 topographical maps, or 1:250000 maps if the catchment covers more than four 1:50 000 sheets.
 - Measure the area of the catchment. Subtract areas of significant internal drainage (eg large pans) if any. Use transparent graph paper with 2mm squares. One hundred squares have an equivalent area of one square kilometer on a 1:50 000 scale map. Count the number of squares to determine the area.
 - Produce a longitudinal profile along the longest tributary from the site to the watershed. Use dividers for measuring the main stream length. These should be set at 0.2 km for 1:50000 maps and 1.0 km for 1:250000 maps. When the latter maps are used the length should be multiplied by a factor 1.2 to correct for a loss of resolution.

The distances along the length of stream where the contour lines are crossed should be used to plot the profile. Where waterfalls and rapids are clearly evident as discontinuities in the profile, the profile should be adjusted downwards to eliminate them.
 - Determine the height difference along the equal area and 1085 slopes.
 - Locate the centroid of the catchment site by eye and measure the distance along the main channel length from the site point to a point opposite the centroid.
- Determine the MAP over the catchment. The catchment MAP is the average of the quaternary catchments within which the catchment of interest is located as shown in the HRU series of publications.
- Determine whether the catchment is located in the coastal or inland region.
- Note the presence of any dams upstream of the site.
- Identify the RMF region in which the site is located and determine the value of the RMF k-factor.
- Determine the catchment characteristics required for the rational method as listed on this sheet.
- Add any other comments relevant.

COMMENTS

FLOOD FREQUENCY ANALYSIS RATIONAL METHOD (CALCULATION SHEET)

GENERAL DATA		TOPOGRAPHY AND GEOLOGY	
PROJECT NO.		CATCHMENT AREA (km ²)	0.0399
RIVER / AREA No.	5	LONGEST WATER COURSE (km)	0.3
ANALYSIS BY	E.Naidoo	1085 HEIGHT DIFFERENCE (m)	2
DATE		DOLOMITIC AREA (%)	0

AREA WEIGHTING FACTORS %					
URBAN	30	RURAL	70	LAKES	0

MAP (mm)
470

PHYSICAL CHARACTERISTICS AND RECOMMENDED VALUES OF RUNOFF COEFFICIENTS (RURAL)						
PHYSICAL CHARACTERISTICS		RECOMM. RUNOFF COEFF. C			C'	CY
STEEPNESS	% OF AREA	MAP				
		< 600	600-900	>900		
< 3 %	100	0.01	0.03	0.05	0.01	0.010
3 to 10%	0	0.06	0.08	0.11	0.06	0.000
10 to 30%	0	0.12	0.16	0.20	0.12	0.000
30 to 50%	0	0.22	0.26	0.30	0.22	0.000
> 50%	0	0.26	0.30	0.34	0.26	0.000
CY = 0.010						

PHYSICAL CHARACTERISTICS AND RECOMMENDED VALUES OF RUNOFF COEFFICIENTS (RURAL)						
PHYSICAL CHARACTERISTICS		RECOMM. RUNOFF COEFF. C			C'	CP
PERMEABILITY	% OF AREA	MAP				
		< 600	600-900	>900		
VERY PERMEABLE	5	0.03	0.04	0.05	0.03	0.002
PERMEABLE	50	0.06	0.08	0.10	0.06	0.030
SEMI-PERMEABLE	40	0.12	0.15	0.20	0.12	0.048
IMPERMEABLE	5	0.21	0.26	0.30	0.21	0.011
CP = 0.090						

PHYSICAL CHARACTERISTICS AND RECOMMENDED VALUES OF RUNOFF COEFFICIENTS (RURAL)						
PHYSICAL CHARACTERISTICS		RECOMM. RUNOFF COEFF. C			C'	CV
VEGETATION	% OF AREA	MAP				
		< 600	600-900	>900		
DENSE BUSH, FOREST	0	0.03	0.04	0.05	0.03	0.000
CULTIVATED LAND	0	0.07	0.11	0.15	0.07	0.000
GRASS LAND	20	0.17	0.21	0.25	0.17	0.034
BARE SURFACE	80	0.26	0.28	0.30	0.26	0.208
CV = 0.242						

PHYSICAL CHARACTERISTICS AND RECOMMENDED VALUES OF RUNOFF COEFFICIENTS (URBAN)						
PHYSICAL CHARACTERISTICS		RECOMM. RUNOFF COEFF. C			C'	CV
OCCUPATION	% OF AREA	MAP				
		< 600	600-900	>900		
LAWNS, PARKS						
SANDY, FLAT < 2 %	45.00	0.05	to	0.10	0.08	0.03
SANDY, STEEP > 7 %	0.00	0.15	to	0.20	0.18	0.00
HEAVY SOIL, FLAT < 2 %	0.00	0.13	to	0.17	0.15	0.00
HEAVY SOIL, STEEP < 7 %	0.00	0.25	to	0.35	0.30	0.00
RESIDENTIAL						
SINGLE DWELLING AREA	0.00	0.30	to	0.50	0.40	0.00
FLATS	0.00	0.50	to	0.70	0.60	0.00
INDUSTRIAL						
LIGHT INDUSTRIES	50.00	0.50	to	0.80	0.65	0.33
HEAVY INDUSTRIES	0.00	0.50	to	0.90	0.70	0.00
BUSINESS						
DOWNTOWN	0.00	0.70	to	0.95	0.83	0.00
NEIGHBOURHOOD	0.00	0.50	to	0.70	0.60	0.00
NEIGHBOURHOOD						
STREETS	5.00	0.70	to	0.95	0.83	0.04
CU = 0.40						

RETURN PERIOD ADJUSTMENT FACTOR		
RETURN PERIOD	RURAL	URBAN
T (years)	t_r	
2	0.75	For return periods equal or greater than 50 years $C_T = 1.00$
5	0.80	
10	0.85	
20	0.90	
50	0.95	
100	1.00	
200	1.00	
$C_T = t_r(C_V + C_P + C_V)$		

TIME OF CON. T_c (hr)
$[0.87 \cdot L^{0.385}]^{0.385}$
0.40

LIGHTNING DENSITY
4

FRANCOU - RODIER REGIONAL COEFF.
5

RAINFALL						
POINT RAINFALL FOR TIME OF CONCENTRATION t_c						
RETURN PERIOD (years)	5	10	20	50	100	200
POINT RAINFALL DEPTH (mm)	23	29	36	47	58	73
POINT INTENSITY (mm/h)	57	73	90	117	144	180
AREA REDUCTION FACTOR %	99	99	98	98	98	97
AVERAGE INTENSITY (mm/h) I_T	57	72	88	114	141	174

AREA WEIGHTED RUNOFF COEFFICIENT						
RETURN PERIOD (years)	5	10	20	50	100	200
RURAL	0.27	0.29	0.31	0.32	0.34	0.34
URBAN	0.40	0.40	0.40	0.40	0.40	0.40
LAKES	0.00	0.00	0.00	0.00	0.00	0.00
AREA WEIGHTED AVERAGE C_T	0.31	0.32	0.34	0.35	0.36	0.36

PEAK DISCHARGE (m ³ / s)						
RETURN PERIOD (years)	5	10	20	50	100	200
$Q_T = 0.278 C_T I_T A$	0.1967	0.2585	0.3276	0.4411	0.5616	0.6948

RECOMMENDED PROCEDURE

- Locate the site on 1:50 000 or 1:250 000 topographical maps.
- Determine the following catchment characteristics for the site:
 - Delineate the catchment boundary on the 1:50 000 topographical maps, or 1:250 000 maps if the catchment covers more than four 1:50 000 sheets.
 - Measure the area of the catchment. Subtract areas of significant internal drainage (eg large pans) if any. Use transparent graph paper with 2mm squares. One hundred squares have an equivalent area of one square kilometer on a 1:50 000 scale map. Count the number of squares to determine the area.
 - Produce a longitudinal profile along the longest tributary from the site to the watershed. Use dividers for measuring the main stream length. These should be set at 0.2 km for 1:50 000 maps and 1.0 km for 1:250 000 maps. When the latter maps are used the length should be multiplied by a factor 1.2 to correct for a loss of resolution.

The distances along the length of stream where the contour lines are crossed should be used to plot the profile. Where waterfalls and rapids are clearly evident as discontinuities in the profile, the profile should be adjusted downwards to eliminate them.
- Determine the height difference along the equal area and 1085 slopes.
- Locate the centroid of the catchment site by eye and measure the distance along the main channel length from the site point to a point opposite the centroid.
- Determine the MAP over the catchment. The catchment MAP is the average of the quaternary catchments within which the catchment of interest is located as shown in the HRU series of publications.
- Determine whether the catchment is located in the coastal or inland region.
- Note the presence of any dams upstream of the site.
- Identify the RMF region in which the site is located and determine the value of the RMF k-factor.
- Determine the catchment characteristics required for the rational method as listed on this sheet.
- Add any other comments relevant.

COMMENTS

FLOOD FREQUENCY ANALYSIS RATIONAL METHOD (CALCULATION SHEET)

GENERAL DATA		TOPOGRAPHY AND GEOLOGY	
PROJECT NO.		CATCHMENT AREA (km ²)	0.0244
RIVER / AREA No.	4	LONGEST WATER COURSE (km)	0.3
ANALYSIS BY	E.Naidoo	1085 HEIGHT DIFFERENCE (m)	2
DATE		DOLOMITIC AREA (%)	0

AREA WEIGHTING FACTORS %					
URBAN	10	RURAL	90	LAKES	0

MAP (mm)
470

PHYSICAL CHARACTERISTICS AND RECOMMENDED VALUES OF RUNOFF COEFFICIENTS (RURAL)						
PHYSICAL CHARACTERISTICS		RECOMM. RUNOFF COEFF. C			C'	CY
STEEPNESS	% OF AREA	MAP				
		< 600	600-900	>900		
< 3 %	100	0.01	0.03	0.05	0.01	0.010
3 to 10%	0	0.06	0.08	0.11	0.06	0.000
10 to 30%	0	0.12	0.16	0.20	0.12	0.000
30 to 50%	0	0.22	0.26	0.30	0.22	0.000
> 50%	0	0.26	0.30	0.34	0.26	0.000
						CV = 0.010

PHYSICAL CHARACTERISTICS AND RECOMMENDED VALUES OF RUNOFF COEFFICIENTS (RURAL)						
PHYSICAL CHARACTERISTICS		RECOMM. RUNOFF COEFF. C			C'	CP
PERMEABILITY	% OF AREA	MAP				
		< 600	600-900	>900		
VERY PERMEABLE	5	0.03	0.04	0.05	0.03	0.002
PERMEABLE	50	0.06	0.08	0.10	0.06	0.030
SEMI-PERMEABLE	40	0.12	0.15	0.20	0.12	0.048
IMPERMEABLE	5	0.21	0.26	0.30	0.21	0.011
						CP = 0.090

PHYSICAL CHARACTERISTICS AND RECOMMENDED VALUES OF RUNOFF COEFFICIENTS (RURAL)						
PHYSICAL CHARACTERISTICS		RECOMM. RUNOFF COEFF. C			C'	CV
VEGETATION	% OF AREA	MAP				
		< 600	600-900	>900		
DENSE BUSH, FOREST	0	0.03	0.04	0.05	0.03	0.000
CULTIVATED LAND	0	0.07	0.11	0.15	0.07	0.000
GRASS LAND	20	0.17	0.21	0.25	0.17	0.034
BARE SURFACE	80	0.26	0.28	0.30	0.26	0.208
						CV = 0.242

PHYSICAL CHARACTERISTICS AND RECOMMENDED VALUES OF RUNOFF COEFFICIENTS (URBAN)						
PHYSICAL CHARACTERISTICS		RECOMM. RUNOFF COEFF. C			C'	CV
OCCUPATION	% OF AREA	MAP				
		< 600	600-900	>900		
LAWNS, PARKS						
SANDY, FLAT < 2 %	45.00	0.05	to	0.10	0.08	0.03
SANDY, STEEP > 7 %	0.00	0.15	to	0.20	0.18	0.00
HEAVY SOIL, FLAT < 2 %	0.00	0.13	to	0.17	0.15	0.00
HEAVY SOIL, STEEP < 7 %	0.00	0.25	to	0.35	0.30	0.00
RESIDENTIAL						
SINGLE DWELLING AREA	0.00	0.30	to	0.50	0.40	0.00
FLATS	0.00	0.50	to	0.70	0.60	0.00
INDUSTRIAL						
LIGHT INDUSTRIES	50.00	0.50	to	0.80	0.65	0.33
HEAVY INDUSTRIES	0.00	0.50	to	0.90	0.70	0.00
BUSINESS						
DOWNTOWN	0.00	0.70	to	0.95	0.83	0.00
NEIGHBOURHOOD	0.00	0.50	to	0.70	0.60	0.00
NEIGHBOURHOOD						
STREETS	5.00	0.70	to	0.95	0.83	0.04
						CU = 0.40

RETURN PERIOD ADJUSTMENT FACTOR		
RETURN PERIOD	RURAL	URBAN
T (years)	t_r	
2	0.75	For return periods equal or greater than 50 years $C_T = 1.00$
5	0.80	
10	0.85	
20	0.90	
50	0.95	
100	1.00	
200	1.00	
$C_T = t_r(C_V + C_P + C_V)$		

TIME OF CON. T_c (hr)
$[0.87 \cdot L^{0.385}]^{0.385}$
0.40

LIGHTNING DENSITY
4

FRANCOU - RODIER REGIONAL COEFF.
5

RAINFALL						
POINT RAINFALL FOR TIME OF CONCENTRATION t_c						
RETURN PERIOD (years)	5	10	20	50	100	200
POINT RAINFALL DEPTH (mm)	23	29	36	47	58	73
POINT INTENSITY (mm/h)	57	73	90	117	144	180
AREA REDUCTION FACTOR %	99	99	98	98	98	97
AVERAGE INTENSITY (mm/h) I_T	57	72	88	114	141	174

AREA WEIGHTED RUNOFF COEFFICIENT						
RETURN PERIOD (years)	5	10	20	50	100	200
RURAL	0.27	0.29	0.31	0.32	0.34	0.34
URBAN	0.40	0.40	0.40	0.40	0.40	0.40
LAKES	0.00	0.00	0.00	0.00	0.00	0.00
AREA WEIGHTED AVERAGE C_T	0.29	0.30	0.32	0.33	0.35	0.35

PEAK DISCHARGE (m ³ /s)						
RETURN PERIOD (years)	5	10	20	50	100	200
$Q_T = 0.278 C_T I_T A$	0.1105	0.1474	0.1893	0.2581	0.3323	0.4112

RECOMMENDED PROCEDURE

- Locate the site on 1:50 000 or 1:250 000 topographical maps.
- Determine the following catchment characteristics for the site:
 - Delineate the catchment boundary on the 1:50 000 topographical maps, or 1:250 000 maps if the catchment covers more than four 1:50 000 sheets.
 - Measure the area of the catchment. Subtract areas of significant internal drainage (eg large pans) if any. Use transparent graph paper with 2mm squares. One hundred squares have an equivalent area of one square kilometer on a 1:50 000 scale map. Count the number of squares to determine the area.
 - Produce a longitudinal profile along the longest tributary from the site to the watershed. Use dividers for measuring the main stream length. These should be set at 0.2 km for 1:50 000 maps and 1.0 km for 1:250 000 maps. When the latter maps are used the length should be multiplied by a factor 1.2 to correct for a loss of resolution.

The distances along the length of stream where the contour lines are crossed should be used to plot the profile. Where waterfalls and rapids are clearly evident as discontinuities in the profile, the profile should be adjusted downwards to eliminate them.
- Determine the height difference along the equal area and 1085 slopes.
- Locate the centroid of the catchment site by eye and measure the distance along the main channel length from the site point to a point opposite the centroid.
- Determine the MAP over the catchment. The catchment MAP is the average of the quaternary catchments within which the catchment of interest is located as shown in the HRU series of publications.
- Determine whether the catchment is located in the coastal or inland region.
- Note the presence of any dams upstream of the site.
- Identify the RMF region in which the site is located and determine the value of the RMF k-factor.
- Determine the catchment characteristics required for the rational method as listed on this sheet.
- Add any other comments relevant.

COMMENTS

FLOOD FREQUENCY ANALYSIS RATIONAL METHOD (CALCULATION SHEET)

GENERAL DATA		TOPOGRAPHY AND GEOLOGY	
PROJECT NO.		CATCHMENT AREA (km ²)	0.021
RIVER / AREA No.	60	LONGEST WATER COURSE (km)	0.2
ANALYSIS BY	E.Naidoo	1085 HEIGHT DIFFERENCE (m)	1
DATE		DOLOMITIC AREA (%)	0

AREA WEIGHTING FACTORS %					
URBAN	20	RURAL	80	LAKES	0

MAP (mm)
470

PHYSICAL CHARACTERISTICS AND RECOMMENDED VALUES OF RUNOFF COEFFICIENTS (RURAL)						
PHYSICAL CHARACTERISTICS		RECOMM. RUNOFF COEFF. C			C'	CY
STEEPNESS	% OF AREA	MAP				
		< 600	600-900	>900		
< 3 %	100	0.01	0.03	0.05	0.01	0.010
3 to 10%	0	0.06	0.08	0.11	0.06	0.000
10 to 30%	0	0.12	0.16	0.20	0.12	0.000
30 to 50%	0	0.22	0.26	0.30	0.22	0.000
> 50%	0	0.26	0.30	0.34	0.26	0.000
					CY =	0.010

PHYSICAL CHARACTERISTICS AND RECOMMENDED VALUES OF RUNOFF COEFFICIENTS (RURAL)						
PHYSICAL CHARACTERISTICS		RECOMM. RUNOFF COEFF. C			C'	CP
PERMEABILITY	% OF AREA	MAP				
		< 600	600-900	>900		
VERY PERMEABLE	5	0.03	0.04	0.05	0.03	0.002
PERMEABLE	50	0.06	0.08	0.10	0.06	0.030
SEMI-PERMEABLE	40	0.12	0.15	0.20	0.12	0.048
IMPERMEABLE	5	0.21	0.26	0.30	0.21	0.011
					CP =	0.090

PHYSICAL CHARACTERISTICS AND RECOMMENDED VALUES OF RUNOFF COEFFICIENTS (RURAL)						
PHYSICAL CHARACTERISTICS		RECOMM. RUNOFF COEFF. C			C'	CV
VEGETATION	% OF AREA	MAP				
		< 600	600-900	>900		
DENSE BUSH, FOREST	0	0.03	0.04	0.05	0.03	0.000
CULTIVATED LAND	0	0.07	0.11	0.15	0.07	0.000
GRASS LAND	20	0.17	0.21	0.25	0.17	0.034
BARE SURFACE	80	0.26	0.28	0.30	0.26	0.208
					CV =	0.242

PHYSICAL CHARACTERISTICS AND RECOMMENDED VALUES OF RUNOFF COEFFICIENTS (URBAN)						
PHYSICAL CHARACTERISTICS		RECOMM. RUNOFF COEFF. C			C'	CV
OCCUPATION	% OF AREA	MAP				
		< 600	600-900	>900		
LAWNS, PARKS						
SANDY, FLAT < 2 %	45.00	0.05	to	0.10	0.08	0.03
SANDY, STEEP > 7 %	0.00	0.15	to	0.20	0.18	0.00
HEAVY SOIL, FLAT < 2 %	0.00	0.13	to	0.17	0.15	0.00
HEAVY SOIL, STEEP < 7 %	0.00	0.25	to	0.35	0.30	0.00
RESIDENTIAL						
SINGLE DWELLING AREA	0.00	0.30	to	0.50	0.40	0.00
FLATS	0.00	0.50	to	0.70	0.60	0.00
INDUSTRIAL						
LIGHT INDUSTRIES	50.00	0.50	to	0.80	0.65	0.33
HEAVY INDUSTRIES	0.00	0.50	to	0.90	0.70	0.00
BUSINESS						
DOWNTOWN	0.00	0.70	to	0.95	0.83	0.00
NEIGHBOURHOOD	0.00	0.50	to	0.70	0.60	0.00
NEIGHBOURHOOD						
STREETS	5.00	0.70	to	0.95	0.83	0.04
					CU =	0.40

RETURN PERIOD ADJUSTMENT FACTOR		
RETURN PERIOD	RURAL	URBAN
T (years)	t_r	
2	0.75	For return periods equal or greater than 50 years $C_T = 1.00$
5	0.80	
10	0.85	
20	0.90	
50	0.95	
100	1.00	
200	1.00	
$C_T = t_r (C_V + C_P + C_V)$		

TIME OF CON. T _c (hr)
$[0.87 * L^{0.3/H}]^{0.385}$
0.33

LIGHTNING DENSITY
4

FRANCOU - RODIER REGIONAL COEFF.
5

RAINFALL						
POINT RAINFALL FOR TIME OF CONCENTRATION t _c						
RETURN PERIOD (years)	5	10	20	50	100	200
POINT RAINFALL DEPTH (mm)	21	27	33	43	53	67
POINT INTENSITY (mm/h)	64	81	99	129	159	199
AREA REDUCTION FACTOR %	99	99	98	98	98	97
AVERAGE INTENSITY (mm/h) I _T	63	80	97	127	156	193

AREA WEIGHTED RUNOFF COEFFICIENT						
RETURN PERIOD (years)	5	10	20	50	100	200
RURAL	0.27	0.29	0.31	0.32	0.34	0.34
URBAN	0.40	0.40	0.40	0.40	0.40	0.40
LAKES	0.00	0.00	0.00	0.00	0.00	0.00
AREA WEIGHTED AVERAGE C _T	0.30	0.31	0.33	0.34	0.35	0.35

PEAK DISCHARGE (m ³ /s)						
RETURN PERIOD (years)	5	10	20	50	100	200
$Q_T = 0.278 C_T I_T A$	0.1099	0.1455	0.1855	0.2513	0.3218	0.3981

RECOMMENDED PROCEDURE

- Locate the site on 1:50 000 or 1:250 000 topographical maps.
- Determine the following catchment characteristics for the site:
 - Demarcate the catchment boundary on the 1:50 000 topographical maps, or 1:250000 maps if the catchment covers more than four 1:50 000 sheets.
 - Measure the area of the catchment. Subtract areas of significant internal drainage (eg large pans) if any. Use transparent graph paper with 2mm squares. One hundred squares have an equivalent area of one square kilometer on a 1:50 000 scale map. Count the number of squares to determine the area.
 - Produce a longitudinal profile along the longest tributary from the site to the watershed. Use dividers for measuring the main stream length. These should be set at 0.2 km for 1:50000 maps and 1.0 km for 1:250000 maps. When the latter maps are used the length should be multiplied by a factor 1.2 to correct for a loss of resolution.
- The distances along the length of stream where the contour lines are crossed should be used to plot the profile. Where waterfalls and rapids are clearly evident as discontinuities in the profile, the profile should be adjusted downwards to eliminate them.
- Determine the height difference along the equal area and 1085 slopes.
- Locate the centroid of the catchment site by eye and measure the distance along the main channel length from the site point to a point opposite the centroid.
- Determine the MAP over the catchment. The catchment MAP is the average of the quaternary catchments within which the catchment of interest is located as shown in the HRU series of publications.
- Determine whether the catchment is located in the coastal or inland region.
- Note the presence of any dams upstream of the site.
- Identify the RMF region in which the site is located and determine the value of the RMF k-factor.
- Determine the catchment characteristics required for the rational method as listed on this sheet.
- Add any other comments relevant.

COMMENTS

FLOOD FREQUENCY ANALYSIS RATIONAL METHOD (CALCULATION SHEET)

GENERAL DATA		TOPOGRAPHY AND GEOLOGY	
PROJECT NO.		CATCHMENT AREA (km ²)	0.0244
RIVER / AREA No.	8	LONGEST WATER COURSE (km)	0.3
ANALYSIS BY	E.Naidoo	1085 HEIGHT DIFFERENCE (m)	2
DATE		DOLOMITIC AREA (%)	0

AREA WEIGHTING FACTORS %					
URBAN	10	RURAL	90	LAKES	0

MAP (mm)
470

PHYSICAL CHARACTERISTICS AND RECOMMENDED VALUES OF RUNOFF COEFFICIENTS (RURAL)						
PHYSICAL CHARACTERISTICS		RECOMM. RUNOFF COEFF. C			C'	CY
STEEPNESS	% OF AREA	MAP				
		< 600	600-900	>900		
< 3 %	100	0.01	0.03	0.05	0.01	0.010
3 to 10%	0	0.06	0.08	0.11	0.06	0.000
10 to 30%	0	0.12	0.16	0.20	0.12	0.000
30 to 50%	0	0.22	0.26	0.30	0.22	0.000
> 50%	0	0.26	0.30	0.34	0.26	0.000
						CV = 0.010

PHYSICAL CHARACTERISTICS AND RECOMMENDED VALUES OF RUNOFF COEFFICIENTS (RURAL)						
PHYSICAL CHARACTERISTICS		RECOMM. RUNOFF COEFF. C			C'	CP
PERMEABILITY	% OF AREA	MAP				
		< 600	600-900	>900		
VERY PERMEABLE	5	0.03	0.04	0.05	0.03	0.002
PERMEABLE	50	0.06	0.08	0.10	0.06	0.030
SEMI-PERMEABLE	40	0.12	0.15	0.20	0.12	0.048
IMPERMEABLE	5	0.21	0.26	0.30	0.21	0.011
						CP = 0.090

PHYSICAL CHARACTERISTICS AND RECOMMENDED VALUES OF RUNOFF COEFFICIENTS (RURAL)						
PHYSICAL CHARACTERISTICS		RECOMM. RUNOFF COEFF. C			C'	CV
VEGETATION	% OF AREA	MAP				
		< 600	600-900	>900		
DENSE BUSH, FOREST	0	0.03	0.04	0.05	0.03	0.000
CULTIVATED LAND	0	0.07	0.11	0.15	0.07	0.000
GRASS LAND	20	0.17	0.21	0.25	0.17	0.034
BARE SURFACE	80	0.26	0.28	0.30	0.26	0.208
						CV = 0.242

PHYSICAL CHARACTERISTICS AND RECOMMENDED VALUES OF RUNOFF COEFFICIENTS (URBAN)						
PHYSICAL CHARACTERISTICS		RECOMM. RUNOFF COEFF. C			C'	CV
OCCUPATION	% OF AREA	MAP				
		< 600	600-900	>900		
LAWNS, PARKS						
SANDY, FLAT < 2 %	45.00	0.05	to	0.10	0.08	0.03
SANDY, STEEP > 7 %	0.00	0.15	to	0.20	0.18	0.00
HEAVY SOIL, FLAT < 2 %	0.00	0.13	to	0.17	0.15	0.00
HEAVY SOIL, STEEP < 7 %	0.00	0.25	to	0.35	0.30	0.00
RESIDENTIAL						
SINGLE DWELLING AREA	0.00	0.30	to	0.50	0.40	0.00
FLATS	0.00	0.50	to	0.70	0.60	0.00
INDUSTRIAL						
LIGHT INDUSTRIES	50.00	0.50	to	0.80	0.65	0.33
HEAVY INDUSTRIES	0.00	0.50	to	0.90	0.70	0.00
BUSINESS						
DOWNTOWN	0.00	0.70	to	0.95	0.83	0.00
NEIGHBOURHOOD	0.00	0.50	to	0.70	0.60	0.00
NEIGHBOURHOOD						
STREETS	5.00	0.70	to	0.95	0.83	0.04
						CU = 0.40

RETURN PERIOD ADJUSTMENT FACTOR		
RETURN PERIOD	RURAL	URBAN
T (years)	t_r	
2	0.75	For return periods equal or greater than 50 years $C_T = 1.00$
5	0.80	
10	0.85	
20	0.90	
50	0.95	
100	1.00	
200	1.00	
$C_T = t_r(C_V + C_P + C_V)$		

TIME OF CON. T_c (hr)
$[0.87 \cdot L^{0.385}]^{0.385}$
0.40

LIGHTNING DENSITY
4

FRANCOU - RODIER REGIONAL COEFF.
5

RAINFALL						
POINT RAINFALL FOR TIME OF CONCENTRATION t_c						
RETURN PERIOD (years)	5	10	20	50	100	200
POINT RAINFALL DEPTH (mm)	23	29	36	47	58	73
POINT INTENSITY (mm/h)	57	73	90	117	144	180
AREA REDUCTION FACTOR %	99	99	98	98	98	97
AVERAGE INTENSITY (mm/h) I_T	57	72	88	114	141	174

AREA WEIGHTED RUNOFF COEFFICIENT						
RETURN PERIOD (years)	5	10	20	50	100	200
RURAL	0.27	0.29	0.31	0.32	0.34	0.34
URBAN	0.40	0.40	0.40	0.40	0.40	0.40
LAKES	0.00	0.00	0.00	0.00	0.00	0.00
AREA WEIGHTED AVERAGE C_T	0.29	0.30	0.32	0.33	0.35	0.35

PEAK DISCHARGE (m ³ /s)						
RETURN PERIOD (years)	5	10	20	50	100	200
$Q_T = 0.278 C_T I_T A$	0.1105	0.1474	0.1893	0.2581	0.3323	0.4112

RECOMMENDED PROCEDURE

- Locate the site on 1:50 000 or 1:250 000 topographical maps.
- Determine the following catchment characteristics for the site:
 - Delineate the catchment boundary on the 1:50 000 topographical maps, or 1:250 000 maps if the catchment covers more than four 1:50 000 sheets.
 - Measure the area of the catchment. Subtract areas of significant internal drainage (eg large pans) if any. Use transparent graph paper with 2mm squares. One hundred squares have an equivalent area of one square kilometer on a 1:50 000 scale map. Count the number of squares to determine the area.
 - Produce a longitudinal profile along the longest tributary from the site to the watershed. Use dividers for measuring the main stream length. These should be set at 0.2 km for 1:50 000 maps and 1.0 km for 1:250 000 maps. When the latter maps are used the length should be multiplied by a factor 1.2 to correct for a loss of resolution.

The distances along the length of stream where the contour lines are crossed should be used to plot the profile. Where waterfalls and rapids are clearly evident as discontinuities in the profile, the profile should be adjusted downwards to eliminate them.
- Determine the height difference along the equal area and 1085 slopes.
- Locate the centroid of the catchment site by eye and measure the distance along the main channel length from the site point to a point opposite the centroid.
- Determine the MAP over the catchment. The catchment MAP is the average of the quaternary catchments within which the catchment of interest is located as shown in the HRU series of publications.
- Determine whether the catchment is located in the coastal or inland region.
- Note the presence of any dams upstream of the site.
- Identify the RMF region in which the site is located and determine the value of the RMF k-factor.
- Determine the catchment characteristics required for the rational method as listed on this sheet.
- Add any other comments relevant.

COMMENTS

FLOOD FREQUENCY ANALYSIS RATIONAL METHOD (CALCULATION SHEET)

GENERAL DATA		TOPOGRAPHY AND GEOLOGY	
PROJECT NO.		CATCHMENT AREA (km ²)	0.021
RIVER / AREA No.	61	LONGEST WATER COURSE (km)	0.2
ANALYSIS BY	E.Naidoo	1085 HEIGHT DIFFERENCE (m)	1
DATE		DOLOMITIC AREA (%)	0

AREA WEIGHTING FACTORS %					
URBAN	20	RURAL	80	LAKES	0

MAP (mm)
470

PHYSICAL CHARACTERISTICS AND RECOMMENDED VALUES OF RUNOFF COEFFICIENTS (RURAL)						
PHYSICAL CHARACTERISTICS		RECOMM. RUNOFF COEFF. C			C'	CY
STEEPNESS	% OF AREA	MAP				
		< 600	600-900	>900		
< 3 %	100	0.01	0.03	0.05	0.01	0.010
3 to 10%	0	0.06	0.08	0.11	0.06	0.000
10 to 30%	0	0.12	0.16	0.20	0.12	0.000
30 to 50%	0	0.22	0.26	0.30	0.22	0.000
> 50%	0	0.26	0.30	0.34	0.26	0.000
					CV =	0.010

PHYSICAL CHARACTERISTICS AND RECOMMENDED VALUES OF RUNOFF COEFFICIENTS (RURAL)						
PHYSICAL CHARACTERISTICS		RECOMM. RUNOFF COEFF. C			C'	CP
PERMEABILITY	% OF AREA	MAP				
		< 600	600-900	>900		
VERY PERMEABLE	5	0.03	0.04	0.05	0.03	0.002
PERMEABLE	50	0.06	0.08	0.10	0.06	0.030
SEMI-PERMEABLE	40	0.12	0.15	0.20	0.12	0.048
IMPERMEABLE	5	0.21	0.26	0.30	0.21	0.011
					CP =	0.090

PHYSICAL CHARACTERISTICS AND RECOMMENDED VALUES OF RUNOFF COEFFICIENTS (RURAL)						
PHYSICAL CHARACTERISTICS		RECOMM. RUNOFF COEFF. C			C'	CV
VEGETATION	% OF AREA	MAP				
		< 600	600-900	>900		
DENSE BUSH, FOREST	0	0.03	0.04	0.05	0.03	0.000
CULTIVATED LAND	0	0.07	0.11	0.15	0.07	0.000
GRASS LAND	20	0.17	0.21	0.25	0.17	0.034
BARE SURFACE	80	0.26	0.28	0.30	0.26	0.208
					CV =	0.242

PHYSICAL CHARACTERISTICS AND RECOMMENDED VALUES OF RUNOFF COEFFICIENTS (URBAN)						
PHYSICAL CHARACTERISTICS		RECOMM. RUNOFF COEFF. C			C'	CV
OCCUPATION	% OF AREA	MAP				
		< 600	600-900	>900		
LAWNS, PARKS						
SANDY, FLAT < 2 %	45.00	0.05	to	0.10	0.08	0.03
SANDY, STEEP > 7 %	0.00	0.15	to	0.20	0.18	0.00
HEAVY SOIL, FLAT < 2 %	0.00	0.13	to	0.17	0.15	0.00
HEAVY SOIL, STEEP < 7 %	0.00	0.25	to	0.35	0.30	0.00
RESIDENTIAL						
SINGLE DWELLING AREA	0.00	0.30	to	0.50	0.40	0.00
FLATS	0.00	0.50	to	0.70	0.60	0.00
INDUSTRIAL						
LIGHT INDUSTRIES	50.00	0.50	to	0.80	0.65	0.33
HEAVY INDUSTRIES	0.00	0.50	to	0.90	0.70	0.00
BUSINESS						
DOWNTOWN	0.00	0.70	to	0.95	0.83	0.00
NEIGHBOURHOOD	0.00	0.50	to	0.70	0.60	0.00
NEIGHBOURHOOD						
STREETS	5.00	0.70	to	0.95	0.83	0.04
					CU =	0.40

RETURN PERIOD ADJUSTMENT FACTOR		
RETURN PERIOD	RURAL	URBAN
T (years)	t_r	
2	0.75	For return periods equal or greater than 50 years $C_T = 1.00$
5	0.80	
10	0.85	
20	0.90	
50	0.95	
100	1.00	
200	1.00	
$C_T = t_r(C_V + C_P + C_V)$		

TIME OF CON. T_c (hr)
$[0.67L^{0.3}H]^{0.385}$
0.33

LIGHTNING DENSITY
4

FRANCOU - RODIER REGIONAL COEFF.
5

RAINFALL						
POINT RAINFALL FOR TIME OF CONCENTRATION t_c						
RETURN PERIOD (years)	5	10	20	50	100	200
POINT RAINFALL DEPTH (mm)	21	27	33	43	53	67
POINT INTENSITY (mm/h)	64	81	99	129	159	199
AREA REDUCTION FACTOR %	99	99	98	98	98	97
AVERAGE INTENSITY (mm/h) I_T	63	80	97	127	156	193

AREA WEIGHTED RUNOFF COEFFICIENT						
RETURN PERIOD (years)	5	10	20	50	100	200
RURAL	0.27	0.29	0.31	0.32	0.34	0.34
URBAN	0.40	0.40	0.40	0.40	0.40	0.40
LAKES	0.00	0.00	0.00	0.00	0.00	0.00
AREA WEIGHTED AVERAGE C_T	0.30	0.31	0.33	0.34	0.35	0.35

PEAK DISCHARGE (m ³ / s)						
RETURN PERIOD (years)	5	10	20	50	100	200
$Q_T = 0.278 C_T I_T A$	0.1099	0.1455	0.1855	0.2513	0.3218	0.3981

RECOMMENDED PROCEDURE

- Locate the site on 1:50 000 or 1:250 000 topographical maps.
- Determine the following catchment characteristics for the site:
 - Demarcate the catchment boundary on the 1:50 000 topographical maps, or 1:250 000 maps if the catchment covers more than four 1:50 000 sheets.
 - Measure the area of the catchment. Subtract areas of significant internal drainage (eg large pans) if any. Use transparent graph paper with 2mm squares. One hundred squares have an equivalent area of one square kilometer on a 1:50 000 scale map. Count the number of squares to determine the area.
 - Produce a longitudinal profile along the longest tributary from the site to the watershed. Use dividers for measuring the main stream length. These should be set at 0.2 km for 1:50 000 maps and 1.0 km for 1:250 000 maps. When the latter maps are used the length should be multiplied by a factor 1.2 to correct for a loss of resolution.

The distances along the length of stream where the contour lines are crossed should be used to plot the profile. Where waterfalls and rapids are clearly evident as discontinuities in the profile, the profile should be adjusted downwards to eliminate them.
- Determine the height difference along the equal area and 1085 slopes.
- Locate the centroid of the catchment site by eye and measure the distance along the main channel length from the site point to a point opposite the centroid.
- Determine the MAP over the catchment. The catchment MAP is the average of the quaternary catchments within which the catchment of interest is located as shown in the HRU series of publications.
- Determine whether the catchment is located in the coastal or inland region.
- Note the presence of any dams upstream of the site.
- Identify the RMF region in which the site is located and determine the value of the RMF k-factor.
- Determine the catchment characteristics required for the rational method as listed on this sheet.
- Add any other comments relevant.

COMMENTS

FLOOD FREQUENCY ANALYSIS RATIONAL METHOD (CALCULATION SHEET)

0.0088

GENERAL DATA		TOPOGRAPHY AND GEOLOGY	
PROJECT NO.		CATCHMENT AREA (km ²)	0.0088
RIVER / AREA No.	6,9	LONGEST WATER COURSE (km)	0.16
ANALYSIS BY	E.Naidoo	1085 HEIGHT DIFFERENCE (m)	1
DATE		DOLOMITIC AREA (%)	0

AREA WEIGHTING FACTORS %					
URBAN	30	RURAL	70	LAKES	0

MAP (mm)
470

PHYSICAL CHARACTERISTICS AND RECOMMENDED VALUES OF RUNOFF COEFFICIENTS (RURAL)						
PHYSICAL CHARACTERISTICS		RECOMM. RUNOFF COEFF. C			C'	CY
STEEPNESS	% OF AREA	MAP				
		< 600	600-900	>900		
< 3 %	100	0.01	0.03	0.05	0.01	0.010
3 to 10%	0	0.06	0.08	0.11	0.06	0.000
10 to 30%	0	0.12	0.16	0.20	0.12	0.000
30 to 50%	0	0.22	0.26	0.30	0.22	0.000
> 50%	0	0.26	0.30	0.34	0.26	0.000
CY =						0.010

PHYSICAL CHARACTERISTICS AND RECOMMENDED VALUES OF RUNOFF COEFFICIENTS (RURAL)						
PHYSICAL CHARACTERISTICS		RECOMM. RUNOFF COEFF. C			C'	CP
PERMEABILITY	% OF AREA	MAP				
		< 600	600-900	>900		
VERY PERMEABLE	5	0.03	0.04	0.05	0.03	0.002
PERMEABLE	50	0.06	0.08	0.10	0.06	0.030
SEMI-PERMEABLE	40	0.12	0.15	0.20	0.12	0.048
IMPERMEABLE	5	0.21	0.26	0.30	0.21	0.011
CP =						0.090

PHYSICAL CHARACTERISTICS AND RECOMMENDED VALUES OF RUNOFF COEFFICIENTS (RURAL)						
PHYSICAL CHARACTERISTICS		RECOMM. RUNOFF COEFF. C			C'	CV
VEGETATION	% OF AREA	MAP				
		< 600	600-900	>900		
DENSE BUSH, FOREST	0	0.03	0.04	0.05	0.03	0.000
CULTIVATED LAND	0	0.07	0.11	0.15	0.07	0.000
GRASS LAND	20	0.17	0.21	0.25	0.17	0.034
BARE SURFACE	80	0.26	0.28	0.30	0.26	0.208
CV =						0.242

PHYSICAL CHARACTERISTICS AND RECOMMENDED VALUES OF RUNOFF COEFFICIENTS (URBAN)						
PHYSICAL CHARACTERISTICS		RECOMM. RUNOFF COEFF. C			C'	CV
OCCUPATION	% OF AREA	MAP				
		< 600	600-900	>900		
LAWNS, PARKS						
SANDY, FLAT < 2 %	45.00	0.05	to	0.10	0.08	0.03
SANDY, STEEP > 7 %	0.00	0.15	to	0.20	0.18	0.00
HEAVY SOIL, FLAT < 2 %	0.00	0.13	to	0.17	0.15	0.00
HEAVY SOIL, STEEP < 7 %	0.00	0.25	to	0.35	0.30	0.00
RESIDENTIAL						
SINGLE DWELLING AREA	0.00	0.30	to	0.50	0.40	0.00
FLATS	0.00	0.50	to	0.70	0.60	0.00
INDUSTRIAL						
LIGHT INDUSTRIES	50.00	0.50	to	0.80	0.65	0.33
HEAVY INDUSTRIES	0.00	0.50	to	0.90	0.70	0.00
BUSINESS						
DOWNTOWN	0.00	0.70	to	0.95	0.83	0.00
NEIGHBOURHOOD	0.00	0.50	to	0.70	0.60	0.00
NEIGHBOURHOOD						
STREETS	5.00	0.70	to	0.95	0.83	0.04
CU =						0.40

RETURN PERIOD ADJUSTMENT FACTOR		
RETURN PERIOD	RURAL	URBAN
T (years)	t_r	
2	0.75	For return periods equal or greater than 50 years $C_T = 1.00$
5	0.80	
10	0.85	
20	0.90	
50	0.95	
100	1.00	
200	1.00	
$C_T = t_r(C_V + C_P + C_V)$		

TIME OF CON. T_c (hr)
$[0.67 \cdot L \wedge 3 / H] \wedge 0.385$
0.30

LIGHTNING DENSITY
4

FRANCOU - RODIER REGIONAL COEFF.
5

RAINFALL						
POINT RAINFALL FOR TIME OF CONCENTRATION t_c						
RETURN PERIOD (years)	5	10	20	50	100	200
POINT RAINFALL DEPTH (mm)	20	26	32	41	51	63
POINT INTENSITY (mm/h)	67	85	105	136	168	210
AREA REDUCTION FACTOR %	99	99	98	98	96	97
AVERAGE INTENSITY (mm/h) I_T	66	84	103	133	164	203

AREA WEIGHTED RUNOFF COEFFICIENT						
RETURN PERIOD (years)	5	10	20	50	100	200
RURAL	0.27	0.29	0.31	0.32	0.34	0.34
URBAN	0.40	0.40	0.40	0.40	0.40	0.40
LAKES	0.00	0.00	0.00	0.00	0.00	0.00
AREA WEIGHTED AVERAGE C_T	0.31	0.32	0.34	0.35	0.36	0.36

PEAK DISCHARGE (m ³ / s)						
RETURN PERIOD (years)	5	10	20	50	100	200
$Q_T = 0.278 C_T I_T A$	0.0506	0.0665	0.0843	0.1134	0.1444	0.1787

RECOMMENDED PROCEDURE

- Locate the site on 1:50 000 or 1:250 000 topographical maps.
- Determine the following catchment characteristics for the site:
 - Demarcate the catchment boundary on the 1:50 000 topographical maps, or 1:250000 maps if the catchment covers more than four 1:50 000 sheets.
 - Measure the area of the catchment. Subtract areas of significant internal drainage (eg large pans) if any. Use transparent graph paper with 2mm squares. One hundred squares have an equivalent area of one square kilometer on a 1:50 000 scale map. Count the number of squares to determine the area.
 - Produce a longitudinal profile along the longest tributary from the site to the watershed. Use dividers for measuring the main stream length. These should be set at 0.2 km for 1:50000 maps and 1.0 km for 1:250000 maps. When the latter maps are used the length should be multiplied by a factor 1.2 to correct for a loss of resolution.

The distances along the length of stream where the contour lines are crossed should be used to plot the profile. Where waterfalls and rapids are clearly evident as discontinuities in the profile, the profile should be adjusted downwards to eliminate them.
- Determine the height difference along the equal area and 1085 slopes.
- Locate the centroid of the catchment site by eye and measure the distance along the main channel length from the site point to a point opposite the centroid.
- Determine the MAP over the catchment. The catchment MAP is the average of the quaternary catchments within which the catchment of interest is located as shown in the HRU series of publications.
- Determine whether the catchment is located in the coastal or inland region.
- Note the presence of any dams upstream of the site.
- Identify the RMF region in which the site is located and determine the value of the RMF k-factor.
- Determine the catchment characteristics required for the rational method as listed on this sheet.
- Add any other comments relevant.

COMMENTS

FLOOD FREQUENCY ANALYSIS RATIONAL METHOD (CALCULATION SHEET)

0.0506

GENERAL DATA		TOPOGRAPHY AND GEOLOGY	
PROJECT NO.		CATCHMENT AREA (km ²)	0.0506
RIVER / AREA No.	50,51,52	LONGEST WATER COURSE (km)	0.2
ANALYSIS BY	E.Naidoo	1085 HEIGHT DIFFERENCE (m)	1
DATE		DOLOMITIC AREA (%)	0

AREA WEIGHTING FACTORS %					
URBAN	42	RURAL	58	LAKES	0

MAP (mm)
470

PHYSICAL CHARACTERISTICS AND RECOMMENDED VALUES OF RUNOFF COEFFICIENTS (RURAL)						
PHYSICAL CHARACTERISTICS		RECOMM. RUNOFF COEFF. C			C'	CY
STEEPNESS	% OF AREA	MAP				
		< 600	600-900	>900		
< 3 %	100	0.01	0.03	0.05	0.01	0.010
3 to 10%	0	0.06	0.08	0.11	0.06	0.000
10 to 30%	0	0.12	0.16	0.20	0.12	0.000
30 to 50%	0	0.22	0.26	0.30	0.22	0.000
> 50%	0	0.26	0.30	0.34	0.26	0.000
					CY = 0.010	

PHYSICAL CHARACTERISTICS AND RECOMMENDED VALUES OF RUNOFF COEFFICIENTS (RURAL)						
PHYSICAL CHARACTERISTICS		RECOMM. RUNOFF COEFF. C			C'	CP
PERMEABILITY	% OF AREA	MAP				
		< 600	600-900	>900		
VERY PERMEABLE	5	0.03	0.04	0.05	0.03	0.002
PERMEABLE	50	0.06	0.08	0.10	0.06	0.030
SEMI-PERMEABLE	40	0.12	0.15	0.20	0.12	0.048
IMPERMEABLE	5	0.21	0.26	0.30	0.21	0.011
					CP = 0.090	

PHYSICAL CHARACTERISTICS AND RECOMMENDED VALUES OF RUNOFF COEFFICIENTS (RURAL)						
PHYSICAL CHARACTERISTICS		RECOMM. RUNOFF COEFF. C			C'	CV
VEGETATION	% OF AREA	MAP				
		< 600	600-900	>900		
DENSE BUSH, FOREST	0	0.03	0.04	0.05	0.03	0.000
CULTIVATED LAND	0	0.07	0.11	0.15	0.07	0.000
GRASS LAND	20	0.17	0.21	0.25	0.17	0.034
BARE SURFACE	80	0.26	0.28	0.30	0.26	0.208
					CV = 0.242	

PHYSICAL CHARACTERISTICS AND RECOMMENDED VALUES OF RUNOFF COEFFICIENTS (URBAN)						
PHYSICAL CHARACTERISTICS		RECOMM. RUNOFF COEFF. C			C'	CV
OCCUPATION	% OF AREA	MAP				
		< 600	600-900	>900		
LAWNS, PARKS						
SANDY, FLAT < 2 %	45.00	0.05	to	0.10	0.08	0.03
SANDY, STEEP > 7 %	0.00	0.15	to	0.20	0.18	0.00
HEAVY SOIL, FLAT < 2 %	0.00	0.13	to	0.17	0.15	0.00
HEAVY SOIL, STEEP < 7 %	0.00	0.25	to	0.35	0.30	0.00
RESIDENTIAL						
SINGLE DWELLING AREA	0.00	0.30	to	0.50	0.40	0.00
FLATS	0.00	0.50	to	0.70	0.60	0.00
INDUSTRIAL						
LIGHT INDUSTRIES	50.00	0.50	to	0.80	0.65	0.33
HEAVY INDUSTRIES	0.00	0.50	to	0.90	0.70	0.00
BUSINESS						
DOWNTOWN	0.00	0.70	to	0.95	0.83	0.00
NEIGHBOURHOOD	0.00	0.50	to	0.70	0.60	0.00
NEIGHBOURHOOD						
STREETS	5.00	0.70	to	0.95	0.83	0.04
					CU = 0.40	

RETURN PERIOD ADJUSTMENT FACTOR		
RETURN PERIOD	RURAL	URBAN
T (years)	t_r	
2	0.75	For return periods equal or greater than 50 years $C_T = 1.00$
5	0.80	
10	0.85	
20	0.90	
50	0.95	
100	1.00	
200	1.00	
$C_T = t_r(C_V + C_P + C_V)$		

TIME OF CON. T_c (hr)
$[0.67L^{0.385}]^{0.385}$
0.33

LIGHTNING DENSITY
4

FRANCOU - RODIER REGIONAL COEFF.
5

RAINFALL						
POINT RAINFALL FOR TIME OF CONCENTRATION t_c						
RETURN PERIOD (years)	5	10	20	50	100	200
POINT RAINFALL DEPTH (mm)	21	27	33	43	53	67
POINT INTENSITY (mm/h)	64	81	99	129	159	199
AREA REDUCTION FACTOR %	99	99	98	98	98	97
AVERAGE INTENSITY (mm/h) I_T	63	80	97	127	156	193

AREA WEIGHTED RUNOFF COEFFICIENT						
RETURN PERIOD (years)	5	10	20	50	100	200
RURAL	0.27	0.29	0.31	0.32	0.34	0.34
URBAN	0.40	0.40	0.40	0.40	0.40	0.40
LAKES	0.00	0.00	0.00	0.00	0.00	0.00
AREA WEIGHTED AVERAGE C_T	0.33	0.34	0.35	0.36	0.37	0.37

PEAK DISCHARGE (m ³ /s)						
RETURN PERIOD (years)	5	10	20	50	100	200
$Q_T = 0.278 C_T I_T A$	0.2894	0.3774	0.4749	0.6350	0.8033	0.9938

RECOMMENDED PROCEDURE

- Locate the site on 1:50 000 or 1:250 000 topographical maps.
- Determine the following catchment characteristics for the site:
 - Demarcate the catchment boundary on the 1:50 000 topographical maps, or 1:250 000 maps if the catchment covers more than four 1:50 000 sheets.
 - Measure the area of the catchment. Subtract areas of significant internal drainage (eg large pans) if any. Use transparent graph paper with 2mm squares. One hundred squares have an equivalent area of one square kilometer on a 1:50 000 scale map. Count the number of squares to determine the area.
 - Produce a longitudinal profile along the longest tributary from the site to the watershed. Use dividers for measuring the main stream length. These should be set at 0.2 km for 1:50 000 maps and 1.0 km for 1:250 000 maps. When the latter maps are used the length should be multiplied by a factor 1.2 to correct for a loss of resolution.

The distances along the length of stream where the contour lines are crossed should be used to plot the profile. Where waterfalls and rapids are clearly evident as discontinuities in the profile, the profile should be adjusted downwards to eliminate them.
- Determine the height difference along the equal area and 1085 slopes.
- Locate the centroid of the catchment site by eye and measure the distance along the main channel length from the site point to a point opposite the centroid.
- Determine the MAP over the catchment. The catchment MAP is the average of the quaternary catchments within which the catchment of interest is located as shown in the HRU series of publications.
- Determine whether the catchment is located in the coastal or inland region.
- Note the presence of any dams upstream of the site.
- Identify the RMF region in which the site is located and determine the value of the RMF k-factor.
- Determine the catchment characteristics required for the rational method as listed on this sheet.
- Add any other comments relevant.

COMMENTS

RATIONAL METHOD (ALTERNATIVE 2) - Oil Trap A			
Size of Catchment, A (km ²)	0.000153	Mean Annual Rainfall (mm)	465.00
Longest Watercourse, L (km)	0.020	Time of Concentration, tc (hours)	0.05
Average Slope, S _{av} (m/m)	0.005	2-year return period daily rainfall, M (mm)	54.90
Combined run-off coefficient, C _r	0.950	Days of Thunder per year, R (days/year)	50
r	0.02		

Return Period	Point Rainfall (mm)	Average Intensity (mm/hr)	Peak flow (m ³ /s)	Peak flow (l/s)
2	5.45	101.37	0.004	4.10
5	9.19	171.01	0.007	6.91
10	12.03	223.69	0.009	9.04
20	14.86	276.37	0.011	11.17
50	18.60	346.01	0.014	13.99
100	21.43	398.69	0.016	16.12
200	24.27	451.37	0.018	18.25

Minimum required pipe diameter

$$Q = VA = \left(\frac{1.49}{n} \right) AR^{\frac{2}{3}} \sqrt{S} \quad [\text{U.S.}]$$

$$Q = VA = \left(\frac{1.00}{n} \right) AR^{\frac{2}{3}} \sqrt{S} \quad [\text{SI}]$$

Assuming full pipe flow :

$$A = \frac{\pi D^2}{4}$$

$$R = \frac{A}{P}, \text{ where } P \text{ is the wetted perimeter of the pipe}$$

$$P = 2\pi r = 2\pi * \frac{D}{2}$$

Therefore:

$$R = \frac{\frac{\pi D^2}{4}}{2\pi * \frac{D}{2}} = \frac{D}{4}$$

Hence:

$$Q = \frac{1}{n} * \left(\frac{\pi D^2}{4} \right) * \left(\frac{D}{4} \right)^{\frac{2}{3}} * S^{\frac{1}{2}}$$

Solving for minimum required pipe diameter, D (in mm):

$$D = \sqrt[8]{\left(\frac{Q}{\left(\frac{S^{1/2} * \pi}{n * 4^{5/3}} \right)} \right)^3} * 1000 = 149.96$$

Inputs	
Q ₅₀ (m3/s)	0.014
v (m/s)	0.79
S (m/m)	0.005
n	0.010

Recommended Pipe	
Use 160mm uPVC pipe Class 4	
MAX, 0.8D (l/s)	14.6
MAX, 0.8D (m3/s)	0.0146
v, 0.8D (m/s)	0.92

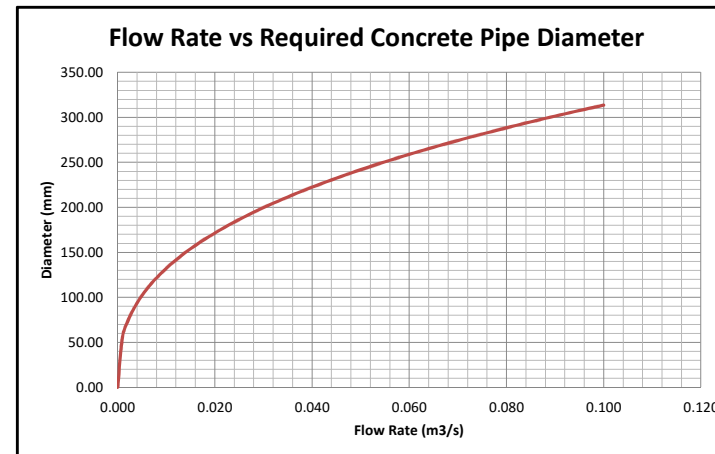

RATIONAL METHOD (ALTERNATIVE 2) - Oil Trap B			
Size of Catchment, A (km ²)	0.00118	Mean Annual Rainfall (mm)	465.00
Longest Watercourse, L (km)	0.015	Time of Concentration, tc (hours)	0.05
Average Slope, S _{av} (m/m)	0.005	2-year return period daily rainfall, M (mm)	54.90
Combined run-off coefficient, C _r	0.950	Days of Thunder per year, R (days/year)	50
r	0.02		

Return Period	Point Rainfall (mm)	Average Intensity (mm/hr)	Peak flow (m ³ /s)	Peak flow (l/s)
2	4.57	96.19	0.003	2.99
5	7.72	162.27	0.005	5.04
10	10.09	212.25	0.007	6.60
20	12.47	262.24	0.008	8.15
50	15.61	328.32	0.010	10.21
100	17.99	378.31	0.012	11.76
200	20.37	428.30	0.013	13.31

Minimum required pipe diameter

$$Q = VA = \left(\frac{1.49}{n}\right) AR^{\frac{2}{3}} \sqrt{S} \quad [\text{U.S.}]$$

$$Q = VA = \left(\frac{1.00}{n}\right) AR^{\frac{2}{3}} \sqrt{S} \quad [\text{SI}]$$

Assuming full pipe flow :

$$A = \frac{\pi D^2}{4}$$

$$R = \frac{A}{P}, \text{ where } P \text{ is the wetted perimeter of the pipe}$$

$$P = 2\pi r = 2\pi * \frac{D}{2}$$

Therefore:

$$R = \frac{\frac{\pi D^2}{4}}{2\pi * \frac{D}{2}} = \frac{D}{4}$$

Hence:

$$Q = \frac{1}{n} * \left(\frac{\pi D^2}{4}\right) * \left(\frac{D}{4}\right)^{\frac{2}{3}} * S^{\frac{1}{2}}$$

Solving for minimum required pipe diameter, D (in mm):

$$D = \sqrt[8]{\left(\frac{Q}{\left(\frac{S^{1/2} * \pi}{n * 4^{5/3}}\right)}\right)^3} * 1000 = \underline{\underline{133.24}}$$

Inputs	
Q ₅₀ (m ³ /s)	0.010
v (m/s)	0.732028
S (m/m)	0.005
n	0.010

Recommend Pipe	
Use 160mm uPVC pipe Class 4	
MAX, 0.8D (l/s)	14.6
MAX, 0.8D (m ³ /s)	0.0146
v, 0.8D (m/s)	0.92

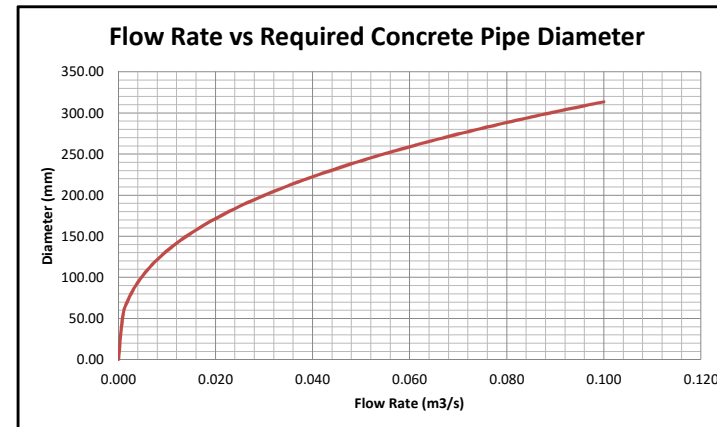

RATIONAL METHOD (ALTERNATIVE 2) - Oil Trap C			
Size of Catchment, A (km ²)	0.000224	Mean Annual Rainfall (mm)	465.00
Longest Watercourse, L (km)	0.029	Time of Concentration, tc (hours)	0.06
Average Slope, S _{av} (m/m)	0.005	2-year return period daily rainfall, M (mm)	54.90
Combined run-off coefficient, C _r	0.950	Days of Thunder per year, R (days/year)	50
r	0.02		

Return Period	Point Rainfall (mm)	Average Intensity (mm/hr)	Peak flow (m ³ /s)	Peak flow (l/s)
2	6.72	104.61	0.006	6.19
5	11.33	176.48	0.010	10.44
10	14.82	230.84	0.014	13.65
20	18.31	285.20	0.017	16.87
50	22.92	357.07	0.021	21.12
100	26.41	411.43	0.024	24.33
200	29.91	465.80	0.028	27.55

Minimum required pipe diameter

$$Q = VA = \left(\frac{1.49}{n}\right) AR^{\frac{2}{3}} \sqrt{S} \quad [\text{U.S.}]$$

$$Q = VA = \left(\frac{1.00}{n}\right) AR^{\frac{2}{3}} \sqrt{S} \quad [\text{SI}]$$

Assuming full pipe flow :

$$A = \frac{\pi D^2}{4}$$

$$R = \frac{A}{P}, \text{ where } P \text{ is the wetted perimeter of the pipe}$$

$$P = 2\pi r = 2\pi * \frac{D}{2}$$

Therefore:

$$R = \frac{\frac{\pi D^2}{4}}{2\pi * \frac{D}{2}} = \frac{D}{4}$$

Hence:

$$Q = \frac{1}{n} * \left(\frac{\pi D^2}{4}\right) * \left(\frac{D}{4}\right)^{\frac{2}{3}} * S^{\frac{1}{2}}$$

Solving for minimum required pipe diameter, D (in mm):

$$D = \sqrt[8]{\left(\frac{Q}{\left(\frac{S^{1/2} * \pi}{n * 4^{5/3}}\right)}\right)^3} * 1000 = 175.00$$

Inputs	
Q ₅₀ (m ³ /s)	0.021
v (m/s)	0.88
S (m/m)	0.005
n	0.01

Recommended Pipe	
Use 200mm uPVC pipe Class 4	
MAX, 0.8D (l/s)	26.5
MAX, 0.8D (m ³ /s)	0.0265
v, 0.8D (m/s)	1.07

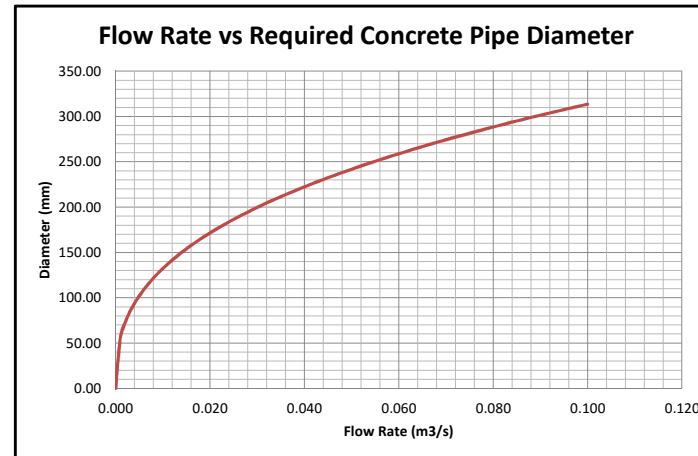

RATIONAL METHOD (ALTERNATIVE 2) - Oil Trap D			
Size of Catchment, A (km ²)	0.000153	Mean Annual Rainfall (mm)	465.00
Longest Watercourse, L (km)	0.020	Time of Concentration, tc (hours)	0.05
Average Slope, S _{av} (m/m)	0.005	2-year return period daily rainfall, M (mm)	54.90
Combined run-off coefficient, C _r	0.950	Days of Thunder per year, R (days/year)	50
r	0.02		

Return Period	Point Rainfall (mm)	Average Intensity (mm/hr)	Peak flow (m ³ /s)	Peak flow (l/s)
2	5.45	101.37	0.004	4.10
5	9.19	171.01	0.007	6.91
10	12.03	223.69	0.009	9.04
20	14.86	276.37	0.011	11.17
50	18.60	346.01	0.014	13.99
100	21.43	398.69	0.016	16.12
200	24.27	451.37	0.018	18.25

Minimum required pipe diameter

$$Q = VA = \left(\frac{1.49}{n}\right) AR^{\frac{2}{3}} \sqrt{S} \quad [U.S.]$$

$$Q = VA = \left(\frac{1.00}{n}\right) AR^{\frac{2}{3}} \sqrt{S} \quad [SI]$$

Assuming full pipe flow :

$$A = \frac{\pi D^2}{4}$$

$$R = \frac{A}{P}, \text{ where } P \text{ is the wetted perimeter of the pipe}$$

$$P = 2\pi r = 2\pi * \frac{D}{2}$$

Therefore:

$$R = \frac{\frac{\pi D^2}{4}}{2\pi * \frac{D}{2}} = \frac{D}{4}$$

Hence:

$$Q = \frac{1}{n} * \left(\frac{\pi D^2}{4}\right) * \left(\frac{D}{4}\right)^{\frac{2}{3}} * S^{\frac{1}{2}}$$

Solving for minimum required pipe diameter, D (in mm):

$$D = \sqrt[8]{\left(\frac{Q}{\left(\frac{S^{1/2} * \pi}{n * 4^{5/3}}\right)}\right)^3} * 1000 = 149.96$$

Inputs	
Q ₅₀ (m3/s)	0.014
v (m/s)	0.792051
S (m/m)	0.005
n	0.010

Recommended Pipe	
Use 160mm uPVC pipe Class 4	
MAX, 0.8D (l/s)	14.6
MAX, 0.8D (m3/s)	0.0146
v, 0.8D (m/s)	0.92

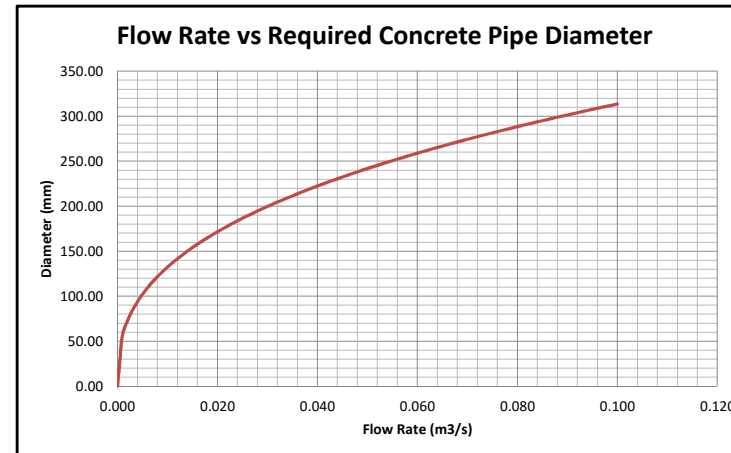

RATIONAL METHOD (ALTERNATIVE 2) - Oil Trap E			
Size of Catchment, A (km ²)	0.000118	Mean Annual Rainfall (mm)	465.00
Longest Watercourse, L (km)	0.015	Time of Concentration, tc (hours)	0.05
Average Slope, S _{av} (m/m)	0.005	2-year return period daily rainfall, M (mm)	54.90
Combined run-off coefficient, C _r	0.950	Days of Thunder per year, R (days/year)	50
r	0.02		

Return Period	Point Rainfall (mm)	Average Intensity (mm/hr)	Peak flow (m ³ /s)	Peak flow (l/s)
2	4.57	96.19	0.003	2.99
5	7.72	162.27	0.005	5.04
10	10.09	212.25	0.007	6.60
20	12.47	262.24	0.008	8.15
50	15.61	328.32	0.010	10.21
100	17.99	378.31	0.012	11.76
200	20.37	428.30	0.013	13.31

Minimum required pipe diameter

$$Q = VA = \left(\frac{1.49}{n} \right) AR^{\frac{2}{3}} \sqrt{S} \quad [\text{U.S.}]$$

$$Q = VA = \left(\frac{1.00}{n} \right) AR^{\frac{2}{3}} \sqrt{S} \quad [\text{SI}]$$

Assuming full pipe flow :

$$A = \frac{\pi D^2}{4}$$

$R = \frac{A}{P}$, where P is the wetted perimeter of the pipe

$$P = 2\pi r = 2\pi * \frac{D}{2}$$

Therefore:

$$R = \frac{\frac{\pi D^2}{4}}{2\pi * \frac{D}{2}} = \frac{D}{4}$$

Hence:

$$Q = \frac{1}{n} * \left(\frac{\pi D^2}{4} \right) * \left(\frac{D}{4} \right)^{\frac{2}{3}} * S^{\frac{1}{2}}$$

Solving for minimum required pipe diameter, D (in mm):

$$D = \sqrt[8]{\left(\frac{Q}{\left(\frac{S^{1/2} * \pi}{n * 4^{5/3}} \right)} \right)^3} * 1000 = 133.24$$

Inputs	
Q ₅₀ (m3/s)	0.010
v (m/s)	0.73
S (m/m)	0.005
n	0.010

Recommended Pipe	
Use 160mm uPVC pipe	
MAX, 0.8D (l/s)	14.6
MAX, 0.8D (m3/s)	0.0146
v, 0.8D (m/s)	0.92

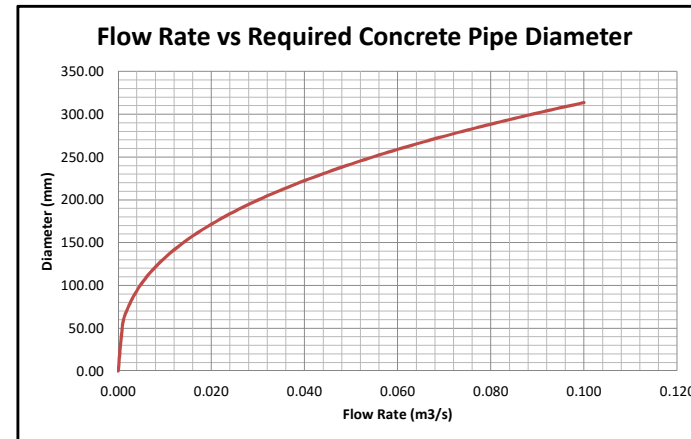

RATIONAL METHOD (ALTERNATIVE 2) - Oil Trap F			
Size of Catchment, A (km ²)	0.000153	Mean Annual Rainfall (mm)	465.00
Longest Watercourse, L (km)	0.020	Time of Concentration, tc (hours)	0.05
Average Slope, S _{av} (m/m)	0.005	2-year return period daily rainfall, M (mm)	54.90
Combined run-off coefficient, C _r	0.950	Days of Thunder per year, R (days/year)	50
r	0.02		

Return Period	Point Rainfall (mm)	Average Intensity (mm/hr)	Peak flow (m ³ /s)	Peak flow (l/s)
2	5.45	101.37	0.004	4.10
5	9.19	171.01	0.007	6.91
10	12.03	223.69	0.009	9.04
20	14.86	276.37	0.011	11.17
50	18.60	346.01	0.014	13.99
100	21.43	398.69	0.016	16.12
200	24.27	451.37	0.018	18.25

Minimum required pipe diameter

$$Q = VA = \left(\frac{1.49}{n}\right) AR^{\frac{2}{3}} \sqrt{S} \quad [\text{U.S.}]$$

$$Q = VA = \left(\frac{1.00}{n}\right) AR^{\frac{2}{3}} \sqrt{S} \quad [\text{SI}]$$

Assuming full pipe flow :

$$A = \frac{\pi D^2}{4}$$

$$R = \frac{A}{P}, \text{ where } P \text{ is the wetted perimeter of the pipe}$$

$$P = 2\pi r = 2\pi * \frac{D}{2}$$

Therefore:

$$R = \frac{\frac{\pi D^2}{4}}{2\pi * \frac{D}{2}} = \frac{D}{4}$$

Hence:

$$Q = \frac{1}{n} * \left(\frac{\pi D^2}{4}\right) * \left(\frac{D}{4}\right)^{\frac{2}{3}} * S^{\frac{1}{2}}$$

Solving for minimum required pipe diameter, D (in mm):

$$D = \sqrt[8]{\left(\frac{Q}{\left(\frac{S^{1/2} * \pi}{n * 4^{5/3}}\right)}\right)^3} * 1000 = 149.96$$

Inputs	
Q ₅₀ (m3/s)	0.014
v (m/s)	0.79
S (m/m)	0.005
n	0.010

Recommended Pipe	
Use 160mm uPVC pipe	
MAX, 0.8D (l/s)	14.6
MAX, 0.8D (m3/s)	0.0146
v, 0.8D (m/s)	0.92

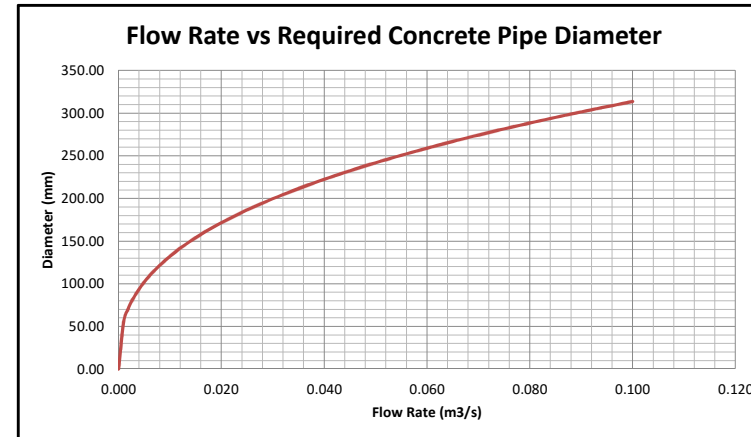

RATIONAL METHOD (ALTERNATIVE 2) - Oil Trap G			
Size of Catchment, A (km ²)	0.000153	Mean Annual Rainfall (mm)	465.00
Longest Watercourse, L (km)	0.020	Time of Concentration, tc (hours)	0.05
Average Slope, S _{av} (m/m)	0.005	2-year return period daily rainfall, M (mm)	54.90
Combined run-off coefficient, C _r	0.950	Days of Thunder per year, R (days/year)	50
r	0.02		

Return Period	Point Rainfall (mm)	Average Intensity (mm/hr)	Peak flow (m ³ /s)	Peak flow (l/s)
2	5.45	101.37	0.004	4.10
5	9.19	171.01	0.007	6.91
10	12.03	223.69	0.009	9.04
20	14.86	276.37	0.011	11.17
50	18.60	346.01	0.014	13.99
100	21.43	398.69	0.016	16.12
200	24.27	451.37	0.018	18.25

Minimum required pipe diameter

$$Q = VA = \left(\frac{1.49}{n}\right) AR^{\frac{2}{3}} \sqrt{S} \quad [\text{U.S.}]$$

$$Q = VA = \left(\frac{1.00}{n}\right) AR^{\frac{2}{3}} \sqrt{S} \quad [\text{SI}]$$

Assuming full pipe flow :

$$A = \frac{\pi D^2}{4}$$

$$R = \frac{A}{P}, \text{ where } P \text{ is the wetted perimeter of the pipe}$$

$$P = 2\pi r = 2\pi * \frac{D}{2}$$

Therefore:

$$R = \frac{\frac{\pi D^2}{4}}{2\pi * \frac{D}{2}} = \frac{D}{4}$$

Hence:

$$Q = \frac{1}{n} * \left(\frac{\pi D^2}{4}\right) * \left(\frac{D}{4}\right)^{\frac{2}{3}} * S^{\frac{1}{2}}$$

Solving for minimum required pipe diameter, D (in mm):

$$D = \sqrt[8]{\left(\frac{Q}{\left(\frac{S^{1/2} * \pi}{n * 4^{5/3}}\right)}\right)^3} * 1000$$

=
149.96

Inputs	
Q ₅₀ (m ³ /s)	0.014
v (m/s)	0.79
S (m/m)	0.005
n	0.010

Recommended Pipe	
Use 160mm uPVC pipe	
MAX, 0.8D (l/s)	14.6
MAX, 0.8D (m ³ /s)	0.0146
v, 0.8D (m/s)	0.92

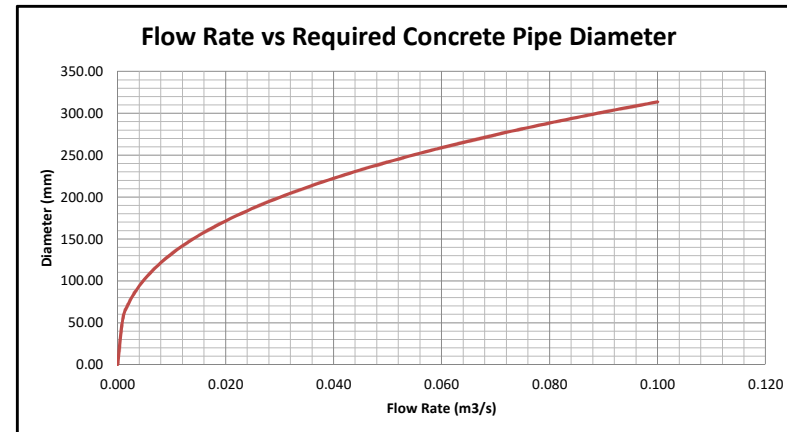

DUROFLO PVC-U
ULTRAFLO PVC-M
Pressure Pipe
Systems

3

ULTRAFLO PVC-M Pressure Pipe

Ultraflo™ PVC-M is a tough and resilient, modified PVC pressure pipe, developed to offer greater strength and toughness. Ultraflo pressure pipes are manufactured in accordance with the SANS 966 Part 2 specification, incorporating a design stress of 18MPa.

Product Range

- Pressure Classes 6, 9, 12, 16, 20 and 25 Bar.
- Working Pressures 600, 900, 1 200, 1 600, 2 000 and 2 500 kPa.
- Length Supplied in standard 6m lengths.
- Outside Diameter Constant for all classes.
- Pipe Ends / Joints Spigot and socket pipe with integral socket and locked-in rubber ring seal.



966 - Part 2

Dimensions

Minimum wall thickness and mass per 6-metre length of each size and class.
(Wall thickness = mm / Mass = kg)

Outside Dia.mm	Class 6		Class 9		Class 12		Class 16		Class 20		Class 25	
	mm	kg	mm	kg	mm	kg	mm	kg	mm	kg	mm	kg
50	1.5	2.1	1.5	2.1	1.7	2.4	2.2	3.0	2.7	3.7	3.3	4.4
63	1.5	2.7	1.6	2.8	2.1	3.7	2.7	4.7	3.4	6.0	4.1	7.0
75	1.5	3.2	1.9	4.0	2.5	5.3	3.2	6.8	4.0	8.2	4.9	10.0
90	1.8	4.6	2.2	5.6	3.0	7.6	3.9	9.7	4.8	11.9	5.9	14.4
110	2.2	6.9	2.7	8.4	3.6	11.1	4.7	14.4	5.8	17.6	7.2	21.5
122	-	-	-	-	4.0	13.3	5.2	17.2	-	-	-	-
125	2.5	8.9	3.1	11.0	4.1	14.4	5.4	19.1	6.6	22.7	8.2	27.9
140	2.8	11.2	3.5	14.2	4.6	18.1	6.0	24.1	7.4	28.6	9.1	35.8
160	3.2	14.6	4.0	18.2	5.2	23.5	6.9	30.8	8.5	37.6	10.4	45.5
177	-	-	-	-	5.8	28.1	7.7	36.8	-	-	-	-
200	3.9	22.3	4.9	27.9	6.5	36.8	8.6	48.2	10.6	60.3	13.0	71.3
250	4.9	35.1	6.1	44.9	8.1	57.6	10.7	75.4	13.2	94.6	16.3	112.5
315	6.2	56.3	7.7	69.7	10.2	91.7	13.5	120.3	16.6	146.7	-	-
355	7.0	72.0	8.7	89.2	11.5	117.3	15.2	153.6	-	-	-	-
400	7.8	90.3	9.8	113.5	13.0	149.8	17.1	195.4	-	-	-	-
450	8.9	116.7	11.0	144.0	14.6	190.1	-	-	-	-	-	-
500	9.8	144.4	12.2	177.7	16.2	234.8	-	-	-	-	-	-
560	11.0	182	13.5	222	17.1	280	23.4	378	-	-	-	-
630	12.5	232	15.4	285	20.4	375	26.9	489	-	-	-	-

Pipe ID	FGD Make-Up Water Pre-Treatment Building			
Pipe Details	160mm uPVC @ 1:200 Fall			
Design Flow Rate (l/s)	Design Velocity (m/s)	Pipe Capacity (l/s), 0.8D	Pipe Velocity (m/s)	Flag (OK/NOT OK)
1.39	0.08	14.59	0.92	OK

Pipe ID	FGD Common Pump Building			
Pipe Details	200mm uPVC @ 1:100 Fall			
Design Flow Rate (l/s)	Design Velocity (m/s)	Pipe Capacity (l/s), 0.8D	Pipe Velocity (m/s)	Flag (OK/NOT OK)
36	1.24	37.54	1.51	OK

Appendix B



FGD Pre-Treatment Building to MH152				
110mm uPVC @ 1:100 Fall to MH152				
Design Flow Rate (l/s)	Design Velocity (m/s)	Pipe Capacity (l/s), 0.8D	Pipe Velocity (m/s)	Flag (OK/NOT OK)
3.78	0.44	7.27	1.00	OK

Common Pump Building to MH1				
110mm uPVC @ 1:200 Fall to MH1				
Design Flow Rate (l/s)	Design Velocity (m/s)	Pipe Capacity (l/s), 0.8D	Pipe Velocity (m/s)	Flag (OK/NOT OK)
1.26	0.07	13.78	0.91	OK

D Building, Shower 1 to MH6				
110mm uPVC @ 1:200 Fall to MH6				
Design Flow Rate (l/s)	Design Velocity (m/s)	Pipe Capacity (l/s), 0.8D	Pipe Velocity (m/s)	Flag (OK/NOT OK)
5.04	0.28	13.78	0.91	OK

D Building, Ablution to MH6				
110mm uPVC @ 1:234 Fall to MH6				
Design Flow Rate (l/s)	Design Velocity (m/s)	Pipe Capacity (l/s), 0.8D	Pipe Velocity (m/s)	Flag (OK/NOT OK)
0.02	0.001	12.74	0.84	OK

ZLD Building, MH6 to MH7				
110mm uPVC @ 1:234 Fall to MH7				
Design Flow Rate (l/s)	Design Velocity (m/s)	Pipe Capacity (l/s), 0.8D	Pipe Velocity (m/s)	Flag (OK/NOT OK)
5.06	0.28	12.74	0.84	OK

LD Building, MH7 to MH89				
110mm uPVC @ 1:250 Fall to MH89				
Design Flow Rate (l/s)	Design Velocity (m/s)	Pipe Capacity (l/s), 0.8D	Pipe Velocity (m/s)	Flag (OK/NOT OK)
5.06	0.28	12.32	0.81	OK

CLASS 34 SOLID WALL (HEAVY DUTY) PIPE - 300 KPA PIPE STIFFNESS

Size: outside diameter mm (OD)	Standard length (m)	Pipe ends	Minimum wall thickness (mm)	Mass kg/m	Code	
110	4 & 6	plain end	3.0	1.546	U110/4HD,01 &	U110/6HD,01
110	6	Integral joint	3.0	1.546		U110/6HD,02
160	4 & 6	plain end	4.7	3.665	SE160/4HD,01 &	SE160/6HD,01
160	6	Integral joint	4.7	3.665		SE160/6HD,02
200	4 & 6	plain end	5.9	5.633	SE200/4HD,01 &	SE200/6HD,01
200	6	Integral joint	5.9	5.633		SE200/6HD,02
250	6	Integral joint	7.4	8.966		SE250/6HD,02
315	6	Integral joint	9.2	14.147		SE315/6HD,02
355	6	Integral joint	10.4	18.445		SE355/6HD,02
400	6	Integral joint	11.8	22.832		SE400/6HD,02
450	6	Integral joint	13.2	29.148		SE450/6HD,02
500	6	Integral joint	14.7	35.908		SE500/6HD,02
560	6	Integral joint	16.3	42.431		SE560/6HD,02
630	6	Integral joint	18.4	53.896		SE630/6HD,02

Appendix C

**CONTRACT NO. 46000050782
TASK ORDER NO. 650**

**CONCEPTUAL DESIGN OF STORMWATER MANAGEMENT,
SEWAGE INFRASTRUCTURE AND ACCESS ROADS BETWEEN THE
BOILER EDGE SLAB AND ROAD NO. 3 (RING ROAD WEST) AND
DESIGN OF THE NEW GYPSUM OFF-TAKE INFRASTRUCTURE
SLAB, ASSOCIATED DRAINAGE, AND ACCESS ROADS**

Traffic Management Plan



19 September 2017

Knight Piésold
CONSULTING



**MERCHELLE'S
COLLECTIVE**

Document Prepared By:

Merchelle's Collective (Pty) Ltd
1 Maxwell Drive
Sunninghill
Sandton
2191

Tel: 011 052 2870
info@merchelles.co.za

Client: Knight Piésold (Pty) Ltd
Contact: Alan Main Pr Eng Pr CM

Author's Signature:



Name: Rochelle Rajasakran Pr Eng
Title: Director

Date: 19 September 2017
Rev: Draft Rev 1

	TABLE OF CONTENTS	PAGE
1	TRANSPORT MANAGEMENT PLAN.....	3
1.1	INTRODUCTION	3
1.2	BACKGROUND.....	3
1.3	PURPOSE OF THE TMP	4
1.4	EXTENT OF STUDY AREA	4
2	REVIEW OF INFORMATION RECEIVED	5
2.1	TRAFFIC IMPACT ASSESSMENT FOR FGD EIA PHASE.....	5
2.1.1	Construction Traffic	5
2.1.2	Operational Traffic.....	5
2.1.3	Traffic Impact Analysis	7
2.1.4	Impact Rating and Mitigation Measures.....	8
2.2	OPERATIONAL AND SITE INFORMATION	8
3	TRAFFIC MANAGEMENT PLAN – DURING CONSTRUCTION	10
3.1	CONSTRUCTION PHASE TRAFFIC.....	10
3.2	MANAGEMENT AND CIRCULATION OF CONSTRUCTION TRAFFIC WITHIN THE SITE.....	11
3.3	IMPROVEMENTS TO THE ROAD NETWORK	14
3.3.1	Capacity Improvements.....	14
3.3.2	Geometric Improvements	14
3.4	NON-MOTORISED TRANSPORT.....	14
4	TRAFFIC MANAGEMENT PLAN – DURING OPERATIONS.....	15
4.1	CONCEPT OF OPERATIONS	15
4.2	OPERATIONAL ANALYSIS	17
4.2.1	Truck Operations.....	17
4.2.2	Weighbridge Operations.....	19
4.2.3	Truck Staging Areas.....	21
4.3	ROAD NETWORK	22
4.3.1	External Road Network.....	22
4.3.2	Internal Road Network.....	22
4.3.3	Access to the Gypsum Off-take Facility	24
4.3.4	Road Pavement Condition.....	25
4.3.5	Signage.....	25
4.3.6	Non-motorised Transport.....	26
4.3.7	Traffic Calming	26
4.3.8	Lighting	27
4.4	COMPLIANCE WITH OCCUPATIONAL HEALTH AND SAFETY	27

4.5	IMPACT STRATEGIES/CONTINGENCY PLANS	27
4.6	REVIEW OF THE TMP	28
5	FURTHER INFORMATION REQUIRED.....	30
6	CONCLUSIONS AND RECOMMENDATIONS.....	31

TABLE OF FIGURES

FIGURE 1-1	STUDY AREA, ROAD NETWORK FOR MEDUPI POWER STATION.....	4
FIGURE 2-1	PM PEAK HOUR TRAFFIC VOLUMES - 2015	6
FIGURE 2-2	SUGGESTED ROUTES FOR TRUCKS TO/FROM POTENTIAL LIMESTONE SOURCES (TIA, HATCH).....	7
FIGURE 2-3	SITE PLAN – REF: MEDUPI POWER STATION DWG No. 178771 – GAU – G10008	
FIGURE 2-4	PHOTO LOG OF INTERNAL ROAD NETWORK.....	9
FIGURE 3-1	CIRCULATION ROUTES FOR CONSTRUCTION VEHICLES	13
FIGURE 4-1	CONCEPT OF OPERATIONS FOR LIMESTONE AND GYPSUM TRUCKS	16
FIGURE 4-2	TYPICAL SIDE-TIPPER TRUCK SPECIFICATIONS	17
FIGURE 4-3	SENSITIVITY ANALYSIS FOR PROCESSING TIME AT THE WEIGHBRIDGE.....	20
FIGURE 4-4	TRUCKS STAGING ON THE SIDE OF THE ROAD – CAMDEN POWER STATION.....	22
FIGURE 4-5	SIDRA INTERSECTION EVALUATION FOR ROAD4/ROAD 26 INTERSECTION.....	23
FIGURE 4-6	DESIGN OF ACCESS ROADS TO GYPSUM OFF-TAKE FACILITY	24
FIGURE 4-7	TRUCK ROUTES TO/FROM THE FDG OFF-TAKE FACILITY	25
FIGURE 4-8	SABS SYMBOLIC SIGNS	26

LIST OF TABLES

TABLE 3-1	ASSUMED CONSTRUCTION-RELATED TRAFFIC	10
TABLE 4-1	ESTIMATED LIMESTONE DELIVERIES TO THE PLANT	18
TABLE 4-2	ESTIMATED GYPSUM REMOVAL FROM THE PLANT	18
TABLE 4-3	RISKS AND MITIGATION MEASURES	27

1 TRANSPORT MANAGEMENT PLAN

1.1 Introduction

Knight Piésold (Pty) Ltd was appointed by Eskom for **Task Order 650: Provision of Engineering and Project Management Services, Contract No. 4600050782**. The project consists of the Conceptual Design of the Stormwater Management, Sewage Infrastructure, Gypsum Off-take Structure and Access Roads between the Boiler Edge Slab and Road No. 3 (Ring Road West). Merchelle's Collective (Pty) Ltd was appointed, as an independent consultant, for the Traffic Management Plan which forms part of the Terms of Reference.

1.2 Background

The Medupi Power Station Flue Gas Desulphurisation (FGD) Retrofit Project consists of the addition of FGD systems to six 800 megawatt (MW) coal fired system electric generating units being constructed in Limpopo Province, approximately 15 kilometres (km) west of the town of Lephalale, South Africa. Medupi's Unit 6 entered commercial operation on 23rd August 2015. The FGD Project will result in the addition of wet limestone open spray tower FGD systems to each of the operating units and will be operational within six years following commercial operation of the respective generating units.

Each of these units has been designed and is being constructed with provisions incorporated into the space and equipment design to accommodate the installation of wet limestone FGD systems. Each of the six FGD absorbers will treat the flue gas from one boiler and commercial-grade saleable gypsum, chemical sludge and chemical solids will be produced as by-products. A cluster of three absorbers will be located near each of the plant's two chimneys. Systems for make-up water, limestone preparation, FGD by-product (gypsum) dewatering and storage/disposal, and treatment of the wastewater stream will be common to all FGD absorbers in the plant.

The FGD areas can be categorised into 2 areas, the limestone off-loading area and the main FGD area. The limestone off-loading area is the area designated for receiving limestone via the new Rail Siding or trucked via a new access road network. The main FGD area is the area on the western side of the existing Boilers, which comprises of the Process and proposed Waste Water Treatment Plants (WWTP). The limestone and gypsum conveyor servitudes connect the main FGD area and limestone off-loading area.

The scope of this project includes the concept design of the new gypsum off-take infrastructure slab, stormwater management system (including water balance), sewage

system and access roads specifically between the Boiler Edge Slab and Road No. 3 (Ring Road West) in the main FGD area.

1.3 Purpose of the TMP

The objectives of the Traffic Management Plan are to:

- Evaluate the planned operation of the site and identify any high risk activities;
- Ensure that the health and safety of employees, contractors and the general public is maintained during these activities;
- Minimise traffic delays by confirming the most feasible routes for the transportation of the various products and by-products as indicated. This will be carried out in accordance with the routes proposed by Eskom;
- Minimise disturbance to the environment;
- Ensure compliance to the OHS Act as well as all relevant codes, standards and statutory requirements; and
- Outline contingency measures.

TMP should be subject to a regular review process and should be amended and re-issued accordingly.

1.4 Extent of Study Area

The TOR indicates that the TMP is limited to the FGD road network and any surrounding impacted roads within the Station. The extent of the road network and subsequent study area that was therefore considered is indicated in Figure 1-1 below.

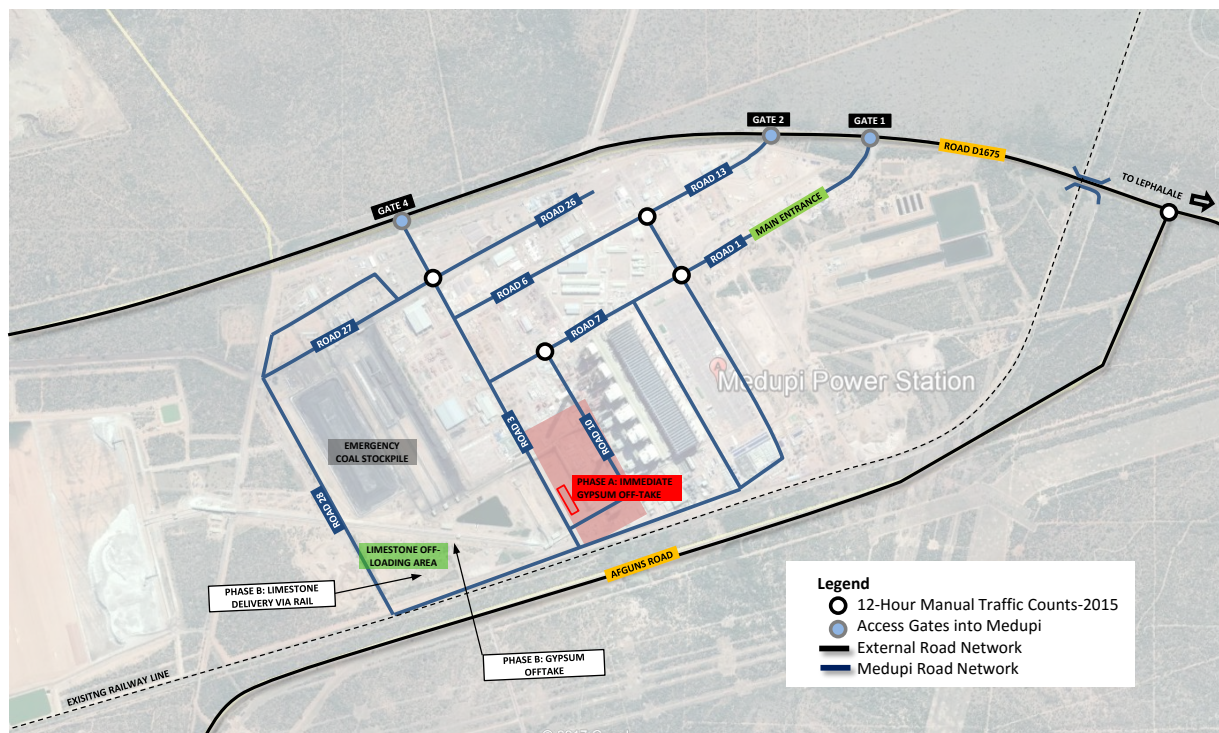

Figure 1-1 Study Area, Road Network for Medupi Power Station

2 REVIEW OF INFORMATION RECEIVED

2.1 Traffic Impact Assessment for FGD EIA Phase

The Traffic Impact Assessment (TIA) was undertaken as part of the Environmental Impact Assessment stage for the implementation of the FGD. The investigation started in October 2015 and was concluded in May 2017. The scope of work for the TIA included an evaluation and impact of the construction and operational traffic of the FGD unit. A total of six 12-hour, manually classified traffic counts were undertaken on both the internal (within the Medupi Power Station) and external road network. The counts were undertaken at the locations shown in Figure 1-1 and described below:

- Nelson Mandela Drive/D1675;
- D1675 / Afguns Road;
- Road 1 / Road 3;
- Road 3 / Road 13;
- Road 7 / Road 10;
- Road 26 / Road 4.

The critical PM Peak hour traffic is illustrated in Figure 2-1 and will be used as input to this study.

2.1.1 Construction Traffic

During the development of the report, no information was available on the volume or the arrival/departure profiles of construction traffic to and from the site and as a result this traffic was not taken into consideration in the analysis of the intersections. Eskom officials indicated that the information contained in the report was the only information available. The construction traffic volumes during the peak hours were therefore estimated and included under Section 3 of this report.

The TIA indicated that most of the project material would be transported to the site by truck from Johannesburg via the N1, R33, R517 and R510. The report recommended that trucks utilise Afguns Road in order to avoid other road users on the main roads. By using the Afguns-Thabazimbi Road, trucks would avoid travelling through Lephalale town and avoid other busy nodes within the study area. The report also provided details regarding the entrance of construction traffic to the site and the various protocols to be followed. These are repeated under Section 3 of the report.

2.1.2 Operational Traffic

The input materials to the FGD process, for the purposes of this study only the limestone material was considered, could be trucked either from Thabazimbi (closest to Medupi Power Station), Marble Hall or Vereeniging. It was suggested that trucks

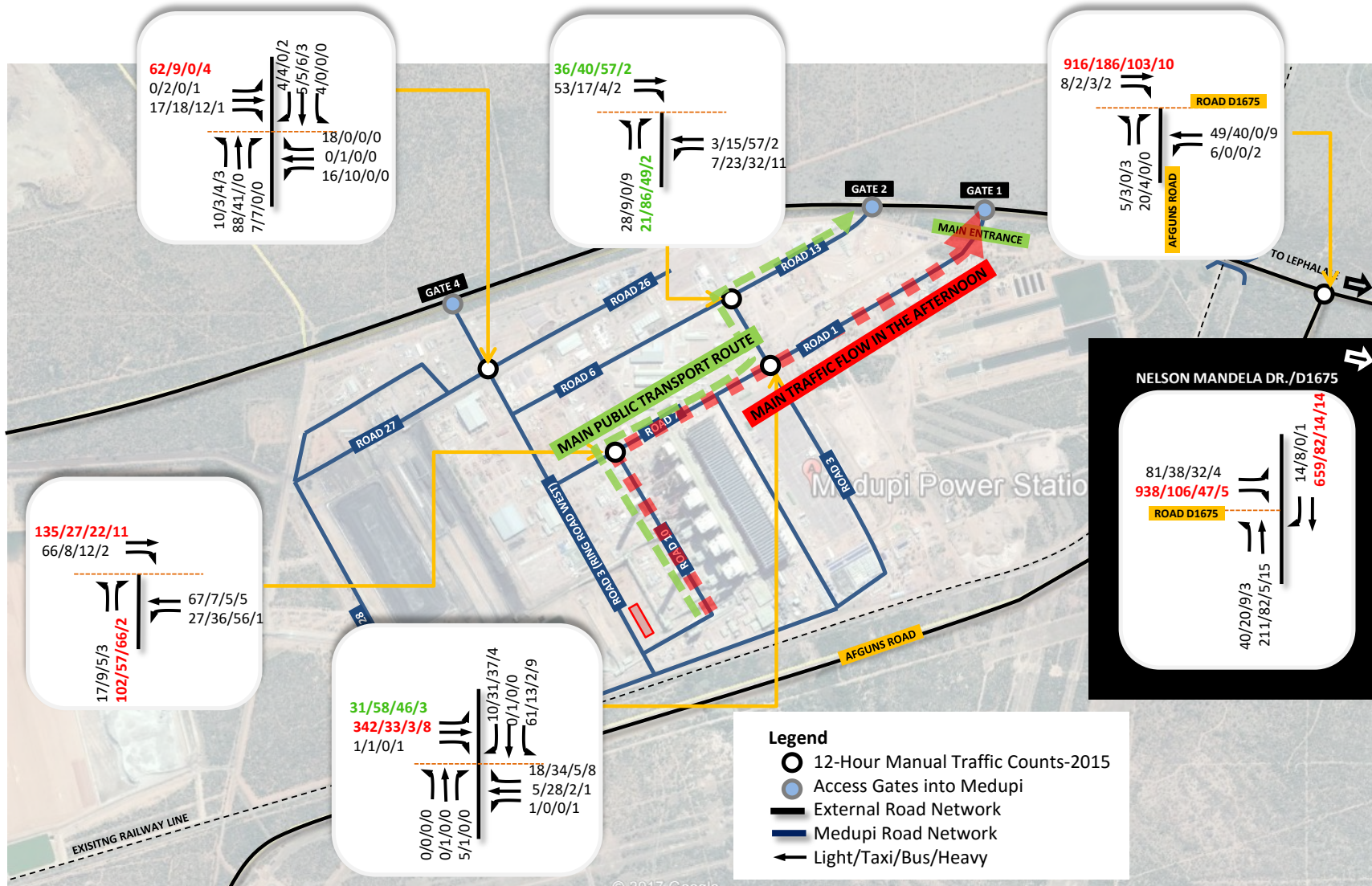

Figure 2-1 PM Peak Hour Traffic Volumes - 2015

delivering limestone to the power station, do so via Afguns Road in order to avoid travelling through Lephalale town. The routes are illustrated in Figure 2-2 below.

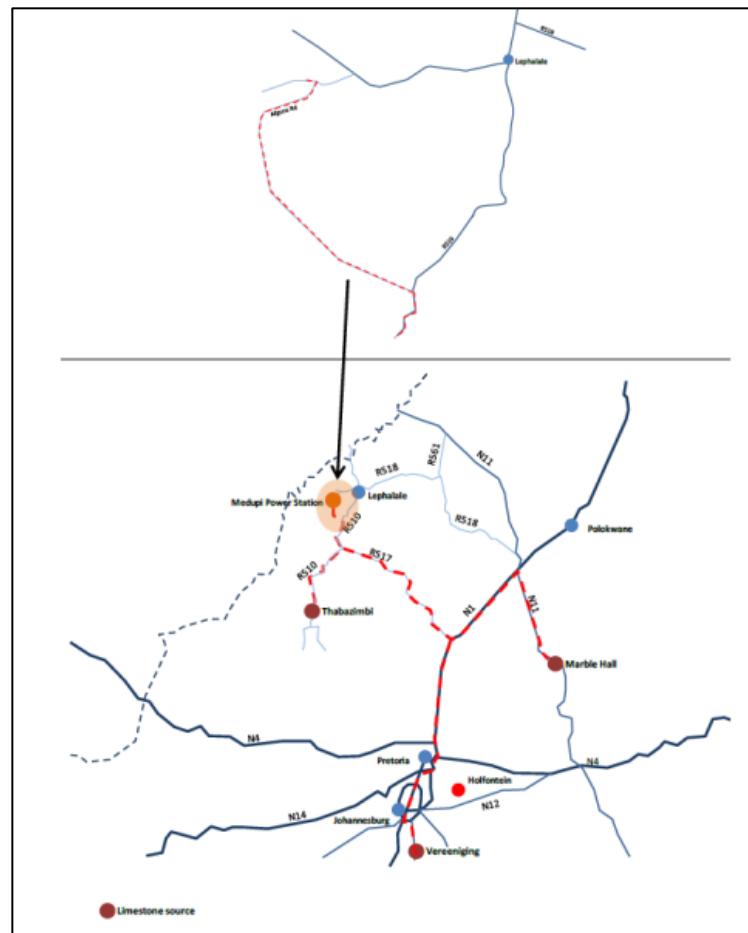

Figure 2-2 Suggested routes for trucks to/from potential limestone sources (TIA, Hatch)

2.1.3 Traffic Impact Analysis

The TIA provided an analysis of intersections on the external road network that would be impacted by the construction and operations related traffic under existing traffic conditions and for a post 10 year development scenario.

The analysis indicated that the **Nelson Mandela Drive/D1675 I/S** currently fails as it operates at LOS F, and will require capacity improvements and upgrade to signal control. The intersection currently has a pointsman directing traffic during the critical pm peak hour, which may be an effective although short term solution.

The second critical intersection is the **Afguns/D1675 I/S** which also currently operates at LOS F on the Afguns Road approach and has a pointsman during the critical pm

peak hour. The report suggests that this intersection be converted to a single lane roundabout or other optimised intersection design in order to function more efficiently.

2.1.4 Impact Rating and Mitigation Measures

The additional traffic on the road due to the construction phase, operational phase and transport of limestone to the site all triggered an impact on the surrounding road environment. The recommendation was the improvement of the abovementioned two intersections.

2.2 Operational and Site information

The Client provided layout drawings of the FGD facility and the proposed operation of the site. The number of limestone and gypsum trucks per day, including the truck dimensions and queue length required was also provided. These are included under Section 4.2 of the report.

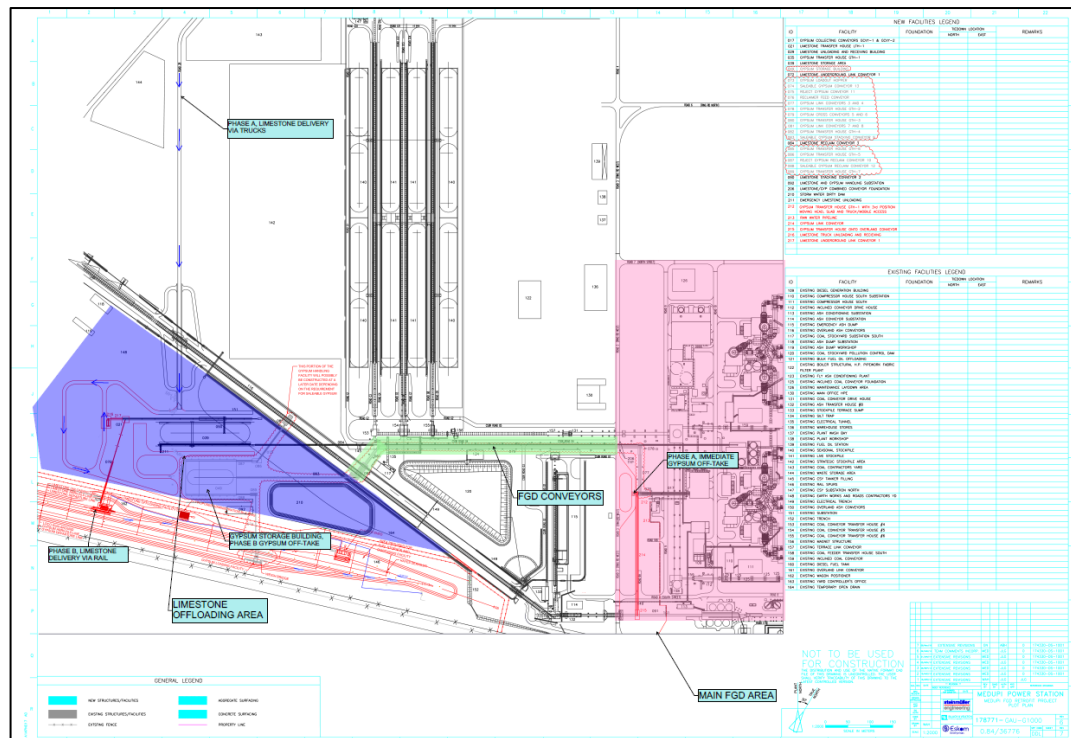

Figure 2-3 Site plan – Ref: Medupi Power Station Dwg No. 178771 – GAU – G1000

A photo log of a recent visit to the Medupi Power Plant is provided in

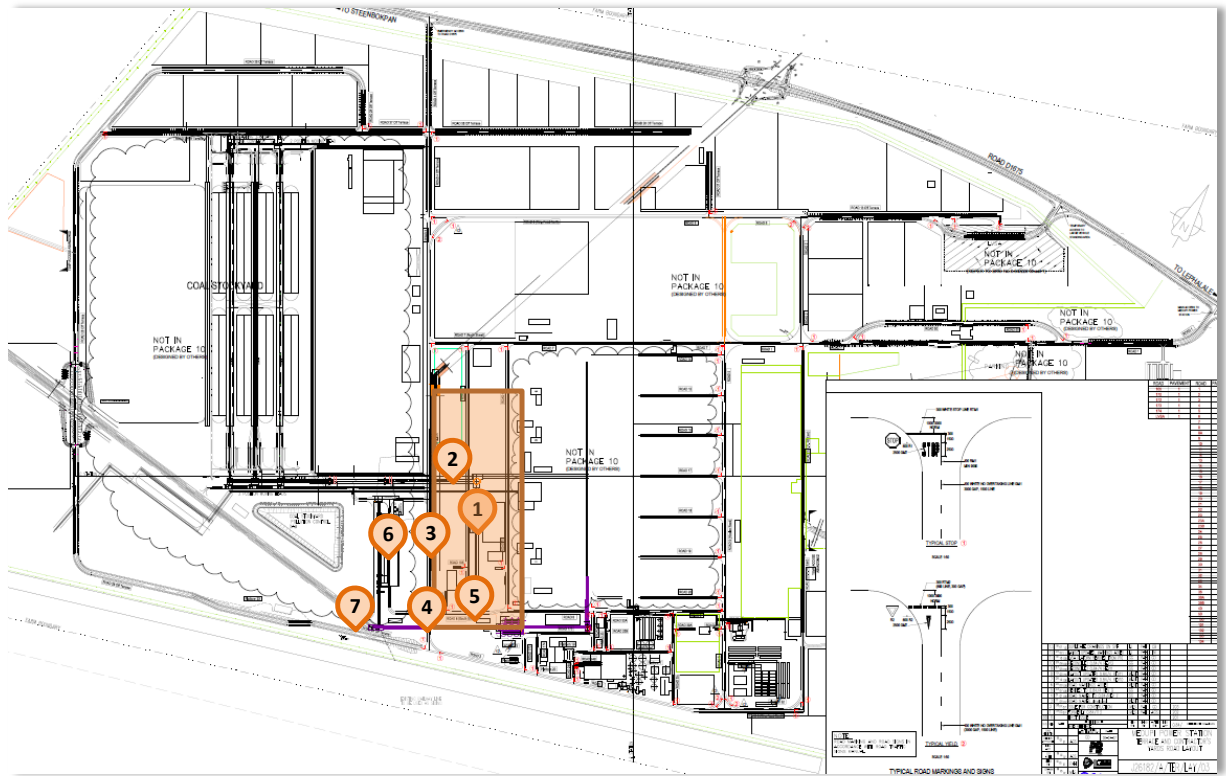

Figure 2-4.

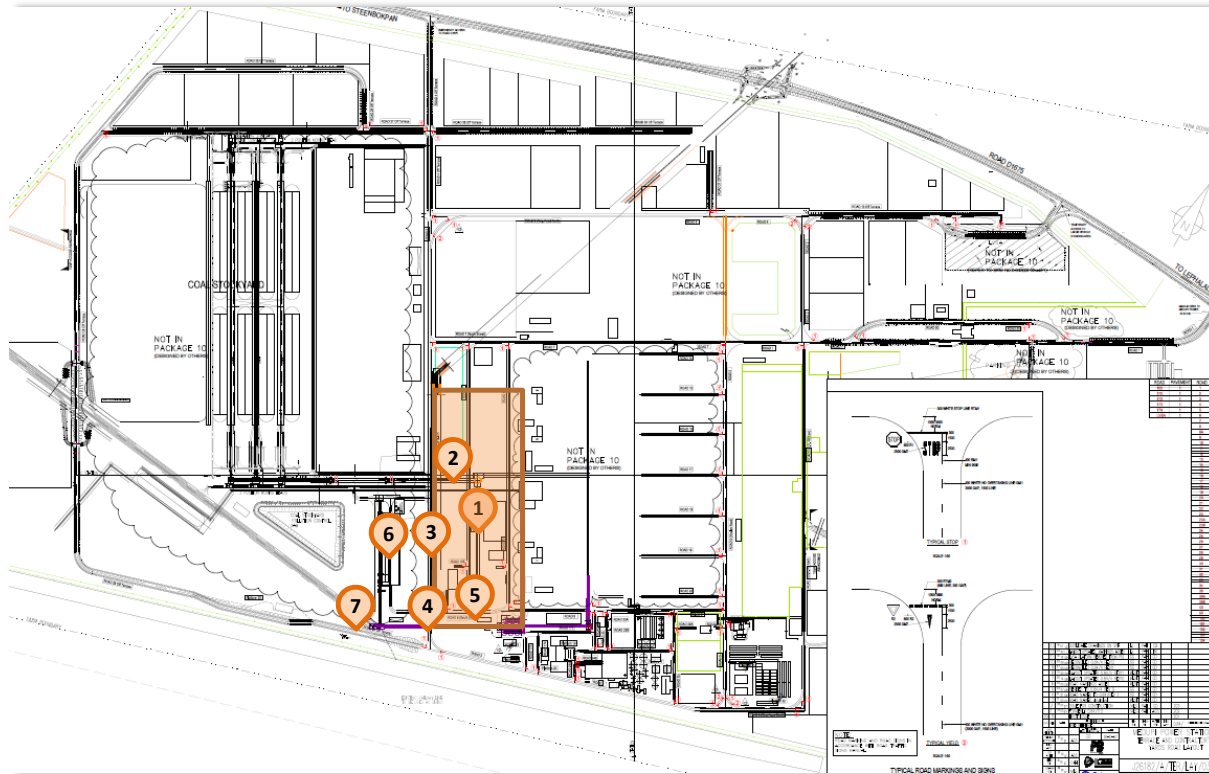

Figure 2-4 Photo log of internal road network

3 TRAFFIC MANAGEMENT PLAN – DURING CONSTRUCTION

The construction traffic will include the following transport and traffic activities:

- Transport of staff, materials and equipment to site
- Transport of abnormal loads to site (this is considered as nil due to the nature of the infrastructure being constructed)
- Management of existing traffic around the site during construction
- Management of construction traffic around the site

3.1 Construction Phase Traffic

This traffic relates directly to the traffic expected during the construction of the stormwater, sewage system, gypsum off-take structure and access roads (truck load and turnaround facility) for the FGD system which is expected to take place over a period of 3-4 months. This traffic is expected to dissipate shortly after completion of construction.

It is assumed that the construction material can be borrowed from a source close to site and that the client will make arrangements for material to be used from this site. Generally, for bulk earth/material transportation 10m³ trucks are used to haul materials from the borrow pit to site. For the purposes of this type of construction it is assumed that 2trips/hour during the peak hour can be expected. Labourers and artisans will most likely be sourced from the town of Lephalale and an additional two minibus-taxis and 3 bakkies during the peak hour is anticipated.

A summary of the assumed construction traffic and trip frequency is provided below (note that this does not include construction vehicles such as dozers, front end loaders, TLB's, water tankers and bob cats since this equipment will not leave the site on a daily basis):

Table 3-1 Assumed construction-related traffic

Vehicle	Daily trips (one direction)	No. of vehicles during the peak hour
30 tonne trucks	12	2/hr
Concrete trucks (during the concrete pour only)	5	1/hr
Minibus taxis (peak hour only)	4	2/hr
Bakkies	6	3/hr

Engineers	1	1/hr
Site supervision staff	2	2/hr
Visitors	1	0/hr
	31 trips/day	11 trips/day

3.2 Management and circulation of construction traffic within the site

Due to the magnitude of the construction activity at Medupi Power Station and the security requirements related to a National Key Point, Eskom have developed certain procedures for construction traffic.

The TIA documented the following procedure:

Staff will be bussed to the site, checked through the permanent plant main access control facility (Entrance gate 1), and transported to their work locations. Empty busses will either exit the site or be parked until end of shift. A parking and load/unloading area for vehicles used on the site to transport personnel from/to remote site areas is located adjacent to the access control facility at the main site entrance. This area will be used only for off-shift parking for staff transport vehicles. Staff, vendors, and visitors arriving on the site via personal vehicles will enter through the main site entrance (Entrance gate 1), pass through access control and drive to a dedicated construction parking lot and office complex located on the southeast side of the plant site. This asphalt surfaced parking area will have approximately 200 parking positions. A special permit will be required to have a personal vehicle on-site and to park in this lot.

A separate site entrance and access control facility is located north of the main site entrance. It is dedicated for material delivery and heavy haul transport trucks and also includes pullover and short-term parking areas for use during security check-in and inspection prior to being allowed onsite for unloading. The construction parking lot and the roads to and from the construction parking and construction entrance are hard surfaced with asphalt to minimize maintenance and provide dust control. Parking areas will be lighted and have barriers to control parking pattern and traffic flow.

In addition to the permanent plant roads and parking facilities, construction roads and parking are required to provide access to temporary construction facilities and lay-down areas in the work areas. The temporary roads are all weather, mostly gravel surfaced, and of sufficient width and location to accommodate efficient use and traffic pattern control for the construction process. Parking at temporary construction facilities and laydown is limited to vehicles necessary for the contractors to conduct work and will be controlled by permit.

Adjacent to the construction security and induction building will be a separate bus depot for drop off and collection of pedestrians and artisans at the pedestrian entrance turnstiles. The buses will enter the construction site through a gate adjacent to these turnstiles to collect and transport the artisans to the contractor's.

*The permanent plant site security organization will manage the plant traffic control program within the perimeter fence on the project site. **Site Security** will be responsible for enforcing speed limits, assigning parking areas and enforcing parking restrictions, installing and maintaining traffic control signs, delineating emergency response and evacuation routes, adjusting traffic patterns to accommodate construction and operation activities, informing plant personnel of current traffic patterns and restrictions, and assisting emergency medical personnel with accident*

*The **Field Management Personnel Staffing Plan** section will be expanded during the execution phase of the project to include paragraphs describing:*

- *Relocation Plans*
- *Personnel De-Staffing Plan*
- *Housing Availability or Camp*
- *Staff Transportation Availability/Plan*
- *Other Considerations*

Eskom officials need to indicate whether this is the procedure that will be followed during the construction of the FGD-related infrastructure and whether it has been developed in more detail.

It is further assumed that Gate 4 will have been constructed and that the design of the security system would be undertaken according to Eskom's "Outline Generic Security Design" system. This design involves the instalment of an Integrated Electronic Access Control System.

Based on the above assumptions, the following protocol (or similar as prescribed by Eskom) is assumed during the construction period:

- **Contractors and site staff** will undergo an initial screening and induction process at Gate 1 and will obtain a security tag. They will thereafter access the site directly via Gate 4. At Gate 4, they will present their security tag, undergo a breathalyser test and sign in. It is assumed that they will have permission to drive through the site and park at the proposed temporary lay-down area;
- **Staff (majority being workers) and vendors** will arrive via public transport, undergo screening at Gate 1 and thereafter pass through the pedestrian turnstiles. They will either walk to the site, which is 2.3km away from Gate 1 (via Road 1 and 7) or take a shuttle bus to the site;
- **Visitors** will park at the visitors parking at Gate 1, and walk to the screening room at Visitors Reception for the breathalyser test, sign in at reception, declaring any weapons, laptops etc. thereafter walk to the Contractors/Visitors shuttle service area through the Visitors Turnstiles. Those with permission to drive into the power station, will walk back to the parking area and drive into the plant;
- **Construction material** will be delivered via the Construction Site entrance (Gate 2) and proceed to the site via Roads 13 and 6.

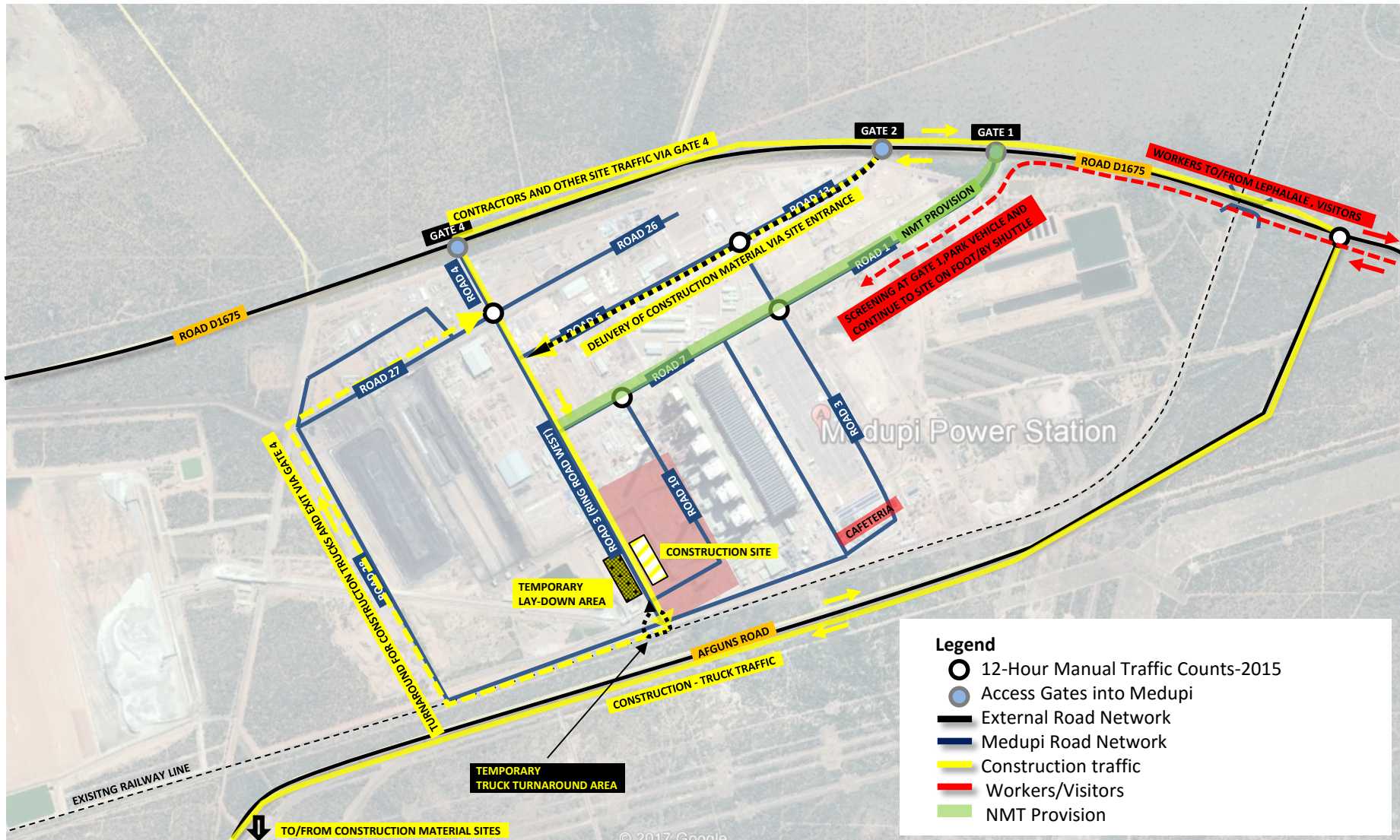

Figure 3-1 Circulation routes for construction vehicles

3.3 Improvements to the road network

3.3.1 Capacity Improvements

An estimated total of **11 trips** will be added to the road network during the peak hour. The **COTO TIA Guidelines** indicate that a traffic impact assessment is only required when more than 50 trips are added to the critical demand movement at an intersection. Given the low demand, it is not anticipated that the road network will deteriorate significantly due to the construction activity. The TIA did, however, indicate that some approaches to the following intersections currently operate at LOS F and a recommendation is therefore made below to alleviate the current situation:

- **Nelson Mandela Drive/D1675 I/S:** This intersection operates as a Two Way Stop Controlled (TWSC) I/S with the D1675 approach under stop control. Based on the traffic count, the major traffic movement is along the D1675 proceeding straight through the intersection towards Lephalale. The intersection is manned by a pointsman during the peak hour. Since the construction activity adds only an additional loading of 10veh/hr to this intersection, it is recommended that the I/S continue to be controlled by a pointsman during the construction period;
- **Afguns Road/D1675 I/S:** This intersection operates as a TWSC I/S with the D1675 approach under stop control. The peak hour traffic on Afguns Road has free flow conditions (observed on Google Earth - *to be confirmed by the Consultants next site visit or by Eskom*) is under 50veh/hr and the peak hour traffic on D1675 is in the region of 1200veh/hr. It is recommended that the road markings be changed such that Afguns Road becomes stop controlled and D1675 has free-flow conditions.

3.3.2 Geometric Improvements

The largest construction vehicle will be a 30 tonne truck and it is assumed that the road network currently accommodates vehicles of this size in terms of turning circles at intersections and lane widths.

3.4 Non-Motorised Transport

Based on the traffic counts undertaken in October 2015, the major movement of construction-related people and vehicles when entering and exiting the plant is along Road 1 and Road 7. This stands to reason as the roads lead to the main entrance gate (Gate 1). People are encouraged, upon entering the Power Station, to move around the site using the bus and minibus taxi service that operate on the internal road network. If there is nonetheless a significant occurrence of pedestrian activity along Roads 1 and 7, sidewalks and appropriate signage, including crossing points, need to be provided to facilitate a safe walking environment.

4 TRAFFIC MANAGEMENT PLAN – DURING OPERATIONS

4.1 Concept of Operations

The FGD process requires limestone as an input, with the by-products being gypsum, salts and sludge. The TMP deals largely with the operations surrounding the delivery of the limestone to the site and the removal of gypsum to an off-site storage area or private company that will make use of the product.

The following procedure is envisaged:

- The limestone will initially be transported to site via truck with the long term plan being to transport the material via rail;
- The gypsum will also initially be removed via truck with the long term plan being to remove the material via rail;
- The vehicles will enter the site through **Gate 4**, where a new security gate access will be constructed. Gate 4 is located at the intersection of Road 4 and Road D1675;
- Two new **weighbridges** will be constructed just inside Gate 4 and it is intended that the inbound and outbound limestone and gypsum trucks will be weighed (both empty and fully loaded vehicles);
- The **limestone trucks** will proceed to the area designated for the limestone stockpile where they will off-load the material. This site will be accessed via Road 4, turning right onto Road 27 and left onto Road 28. The truck will then turnaround and proceed back to Gate 4 along the same Roads 28 and 27;
- The **gypsum trucks** will proceed to the gypsum off-take facility where they will drive onto a concrete slab and receive the gypsum via a conveying system. This same conveyor system is used to transfer ash to the northern ash dump. The conveyor system will be expanded into Phase B, which includes a Gypsum Storage Building and Rail Facility for permanent, long term operations. Phase B does not form part of this scope. The trucks will enter via Gate 4 and proceed to site via Road 4 and Road 3 Ring Road West. The road system servicing the off-take facility is designed for the truck to drive to a position under the conveyor belt, receive the gypsum and turnaround on Road 3 Ring Road West and proceed to Gate 4. Alternatively the full trucks may turn left onto Road 3 Ring Road West, right onto Road 28, right onto Road 27 and left onto Road 4 to exit at Gate 4;
- The proposed limestone and gypsum truck routes do not overlap, except for a short section of Road 4 when they enter the site;
- The need to reverse should be kept to a minimum as should overtaking of another truck;
- By-products of the water treatment process, **salts and sludge**, are also removed from the WWTP which is situated on the corner of Road 7 and Road 10. An estimated 13 trucks per day (based on the TIA) which will also make use of Gate 4 and be weighed at the weighbridge, thereafter turn left into Road 7.

The concept of operations described above is illustrated in Figure 4-1.

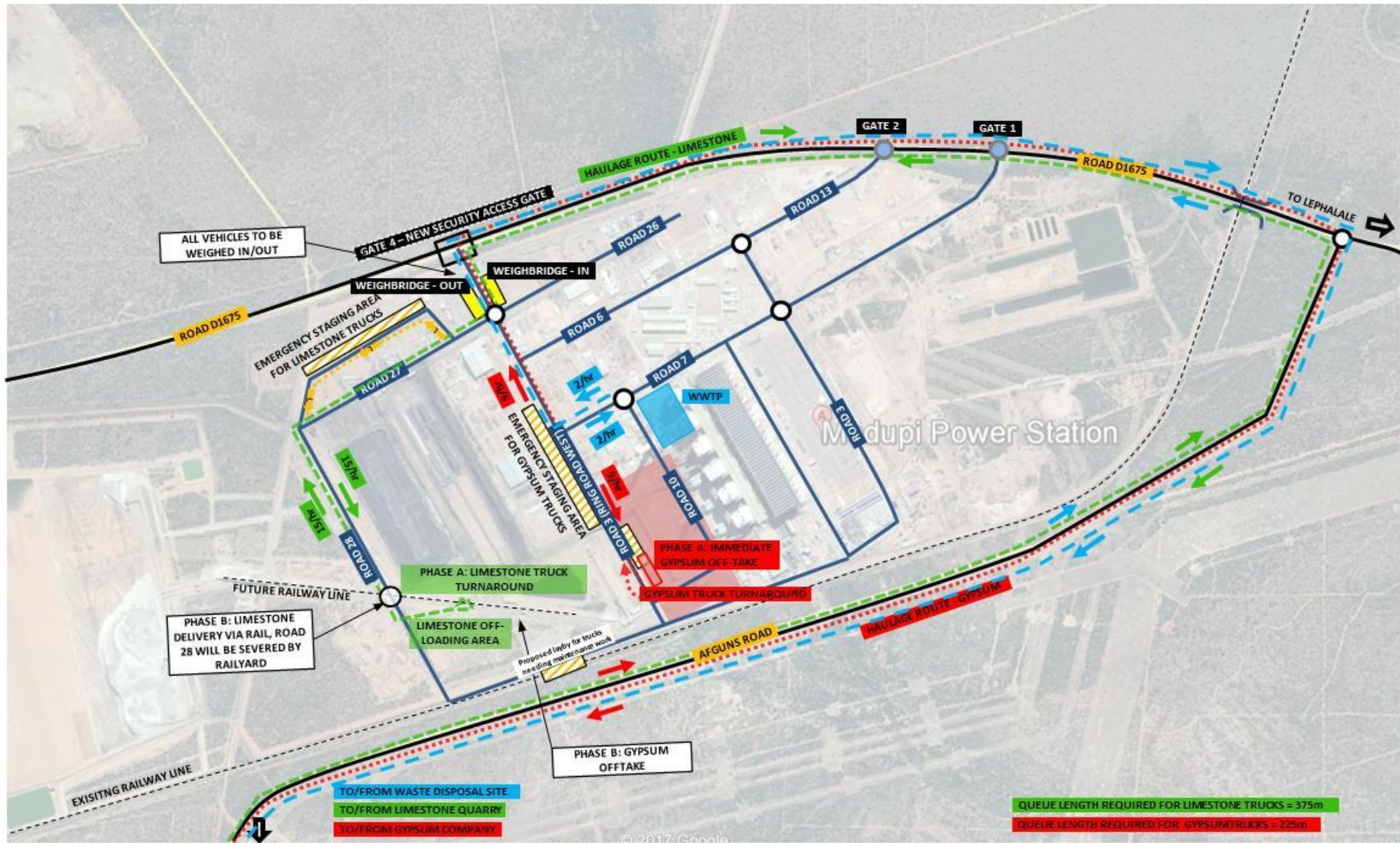

Figure 4-1 Concept of operations for limestone and gypsum trucks

Phase B entails the transportation of limestone and gypsum via rail. Once the railway infrastructure is built, Road 28 will be severed on the southern side, just after the limestone off-take area. As a result, trucks from the gypsum off-take facility will only be able to use Road 3 with no other alternative route. Although, once Phase B is operational there will be less reliance on trucks to transport the material resulting in minimal truck volumes on these roads.

4.2 Operational Analysis

4.2.1 Truck Operations

Eskom provided the following information on the truck specifications and logistics of the movements around the limestone and gypsum facilities (*ref: Medupi FGD Roads Design Trucking info _ rev 0*):

- It is assumed that conventional bulk side-tipper trucks may be used for the delivery of limestone and the removal of gypsum.
- The length of the truck is 25m with 7 axles and the typical specifications are shown in Figure 4-2 below:

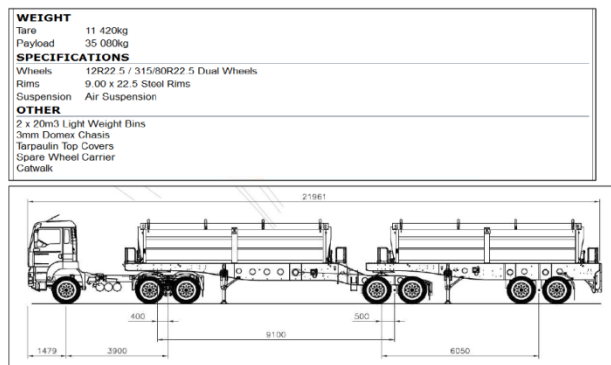

Figure 4-2 Typical Side-tipper Truck Specifications

4.2.1.1 Limestone Trucks

The trucks will operate for 12 hours a day, five days a week.

Table 4-1 indicates the expected daily number of truck loads required for the transport of limestone to the FGD. Based on an even distribution, a total of 15 trucks can be expected to arrive per hour on a weekday. The average processing time at the limestone off-loading facility is 3 minutes. A total of 20 trucks can be processed per hour. The total queue length that can be expected during the off-loading facility downtime is 15 vehicles. The total downtime is expected to be 1 hour.

The total truck queue length that needs to be accommodated during the downtime is 375m.

Table 4-1 Estimated limestone deliveries to the plant

Item	Units	Value
Limestone Deliveries		
Expected Truck Payload Capability (Double-bin interlink truck)	tonnes	35
Average number of Trucks per Hour - continuous basis	trucks/hour	5.1
Expected Actual Number of Operating Hours Per Day	hours	12
Expected Actual Number of Operating Days Per Week	days	5
Average Number of Trucks Required per 7 day week, over 5 days, even distribution	trucks/week	849.60
Average Number of Trucks Required per week-day, over 12 hours, even distribution	trucks/day	170
Average Number of Trucks Required per week-day hour, even distribution	trucks/hour	14.2 (say 15)
Truck Processing Time @ Limestone Off-loading Facility	mins	3
Assumed Intermittent Off-loading Facility Down Time Duration	hours	1
Number of Trucks in Queue (15trucks x 1hrs)	no.	15
Truck Queue Length to be catered for (25m x 15 trucks)	m	375

(Ref: Medupi FGD Roads Design Trucking info _ rev 0)

4.2.1.2 Gypsum Trucks

Based on the information provided in Table 4-2, the number of daily truck loads required for the removal of gypsum is 99 trucks. Based on a 12-hour operational day, it can be expected that a maximum number of 9 truckloads will be removed during the peak hour, if the delivery schedule is evenly distributed throughout the day. The average processing time at the gypsum load-out facility is 7 minutes. A total of 9 trucks can be processed per hour. The total queue length that can be expected during the load-out facility downtime is 9 vehicles. The total downtime is expected to be 1 hour.

The total truck queue length that needs to be accommodated during the downtime is 225m.

Table 4-2 Estimated gypsum removal from the plant

Item	Units	Value
Gypsum Export		
Gypsum Export per hour	tph	102.67
Gypsum Export per day	tonnes/day	2 464.00
Gypsum Export per week	tonnes/week	17 248.00
Gypsum Export per year	tonnes/annum	899 360.00

Expected Truck Payload Capability (Double Bin Interlink Truck)	tonnes	35
Average number of Trucks per Hour - continuous basis	trucks/hour	8.8
Expected Actual Number of Operating Hours Per Day	hours	12
Expected Actual Number of Operating Days Per Week days	days	5
Average Number of Trucks Required per 7 day week, over 5 days, even distribution	trucks/week	492.8
Average Number of Trucks Required per week-day, over 12 hours, even distribution	trucks/day	99
Average Number of Trucks Required per week-day hour, even distribution	trucks/hour	8.2 (say 9)
Truck Processing Time @ Gypsum Load-Out Facility (Prod Rate of 308tph @ 35tonnes/truck) mins 6.82	mins	6.82 (say 10)
Assumed Intermittent Load Out Facility Down Time Duration	hours	1
Number of Trucks in Queue (9trucks x 1hrs)	no.	9
Truck Que Length to be catered for (25m x 9 trucks)	m	225

4.2.2 Weighbridge Operations

Eskom have plans in place to construct a weighbridge at Gate 4. The weighbridge will allow for the weighing of delivery trucks carrying the following loads:

- Fuel oil;
- Limestone;
- Gypsum;
- Salts and sludge from the WWTP;
- Any other loads that require to be verified.

The weighbridge will consist of two bi-directional weighbridges. Each system will allow for haulage traffic to be weighed in both directions.

The total number of trucks that need to be weighed on a daily basis is as follows:

- The number of limestone trucks that need to be weighed on the way in and out is 15 trucks/hr.;
- The number of gypsum trucks that need to be weighed on the way in and out is 9 trucks/hr. It should be noted that the gypsum trucks may need to be covered with tarpaulin, which needs to be removed when weighed;
- The number of trucks to/from the WWTP is 13/day, assuming a maximum of 2/hr.

This amounts to a total of 26 trucks/hr. The average processing time at the weighbridge is critical in determining whether the two weighbridges are sufficient in accommodating the demand. A sensitivity analysis was conducted for a processing

time of between 2.5 and 5 minutes per weighbridge. The results are shown in Figure 4-3 below.

Assuming a conservative average of 3.5 minutes per truck (and that the tarpaulin is removed from the gypsum trucks before they enter the weighbridge queue, the total number of trucks that can be processed by one weighbridge is 17 trucks/hr. Based on a uniform arrival/departure rate of all trucks to/from the plant, there is a risk that the proposed two weighbridges will be operating over capacity.

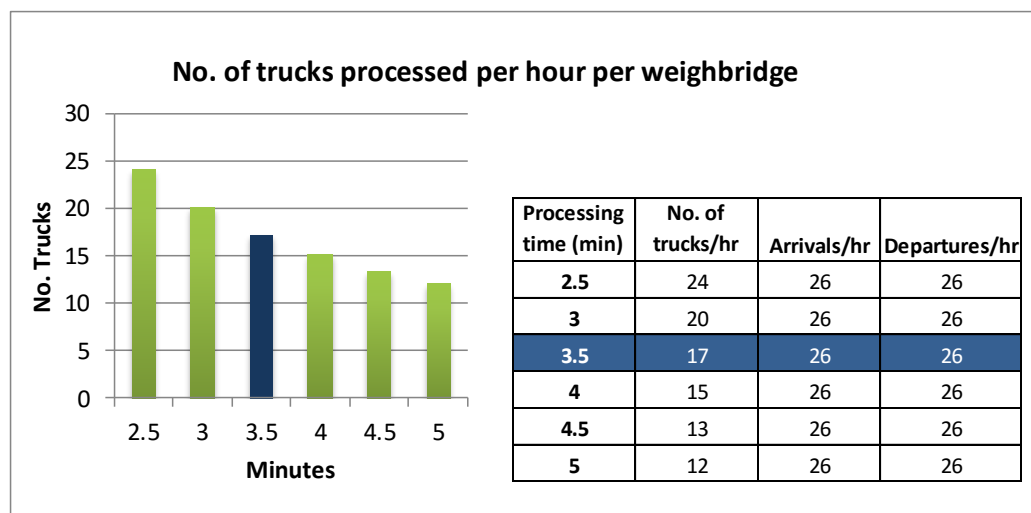

Figure 4-3 Sensitivity analysis for processing time at the weighbridge

In addition to the above risk, should the weighbridge require maintenance or is out of order for an hour, a significant queue could build up between the weighbridge and the D1675/Gate 4 Intersection. This queue could spill over onto the D1675.

The following recommendations are therefore made with regard to the weighbridge operations:

- Eskom confirm that the above number of truck movements can be expected at the weighbridge, in which case the demand exceeds the capacity of the two weighbridges. It is then recommended that a third bi-directional bridge be constructed;
- The TIA recommended that a traffic count at the D1675/Gate 4 be conducted to assess the impact of trucks queueing on the D1675, should the weighbridge be out of order or over-capacity. A detailed plan showing the queueing distance available between the weighbridge and the public road should be compiled, including a truck scheduling programme to confirm all truck movements at the Gate and the weighbridge;
- Depending on the outcome of the above investigation, Eskom may need to create a staging area between Gate 4 and the weighbridge for overflow trucks at the weighbridge.

- The removal of the tarpaulin from the gypsum trucks should also be conducted at separate stations, away from the weighbridge area. An adequate number of stations should be provided, so that the procedure does not cause delays at the weighbridge.

4.2.3 Truck Staging Areas

If the gypsum off-take facility or the limestone stockpile area is out of order due to maintenance or a mechanical fault or inclement weather, then sufficient queuing area is required for the limestone and gypsum trucks that continue to arrive at site.

The following area is required:

- 375m for limestone trucks (accommodates 15 trucks)
- 225m for gypsum trucks (accommodates 9 trucks)

The road network on the western side of the plant is sufficiently quiet to enable the staging of trucks along the road. It is recommended that:

- The limestone trucks be allowed to stage above Road 27 at the current contractors lay down area and;
- The gypsum trucks stage along Road 3 Ring Road West, opposite the gypsum off-take facility. Sufficient area is available on the side of the road to accommodate 9 trucks over an hour. The traffic count at Road 6/Road 26 indicates very low traffic volumes along Road 4, being in the order of 100veh/hr during the peak hour. This traffic probably turns into Road 7 before it gets to Road 3 Ring Road West. Site observations also indicated that minimal traffic uses this road. In addition to this queuing space, the geometric design of the access roads to the off-take facility can accommodate a further 7 queued vehicles (discussed under Section 4.3). During this time, the limestone or gypsum companies need to be notified to stop dispatching trucks to the plant until the areas are operational again;
- Trucks need to park with sufficient space in front of the truck to enable independent departures of trucks i.e. if a truck has been waiting in the queue for too long and is recalled to the mine/gypsum company, he will be able to manoeuvre out of his parking bay and leave the staging area;
- It is further recommended that a maintenance bay be constructed along the southern portion of Road 28 to accommodate at least two trucks that could be broken down and may require maintenance.

The above-mentioned areas are shown in Figure 4 1.

Figure 4-4 shows an example of trucks staging on the side of the road (internal road at Camden Power Station).



Figure 4-4 Trucks staging on the side of the road – Camden Power Station

4.3 Road Network

4.3.1 External Road Network

An estimated total of 26 heavy vehicle trips will be added to the road network during the peak hour. The following improvements to the road network are deemed necessary:

- **Nelson Mandela Drive/D1675 I/S:** The gypsum, limestone and salts/sludge trucks will turn right at this intersection from the D1675 and join Nelson Mandela Drive. Currently, drivers find it difficult to find a gap in traffic and the pointsman is on duty there to direct traffic during the peak hours. The TIA recommended that this intersection be upgraded and signalised, which is further endorsed by this TMP. In addition to this, a protected right turn phase from the D1675 into Nelson Mandela Drive should be provided throughout the day, to enable the safe turning movement of the interlink trucks;
- **Afguns Road/D1675 I/S:** The re-striping of the stop line from D1675 to Afguns Road (to be confirmed that D1675 is currently under stop control) should be monitored and if the traffic flow improves then no further improvements to the intersection may be necessary.

4.3.2 Internal Road Network

An evaluation of the internal road network was conducted using the Road 27/Road 4 Intersection. The intersection was analysed using SIDRA, an intersection evaluation software programme to determine the general capacity of the internal road network.

The results for the PM Peak hour, using the counts undertaken during October 2015, and adding the limestone (15veh/hr.), gypsum (9veh/hr.) and salt/sludge (2/hr.) truck movements is provided in Figure 4-5 below. It is assumed that the vehicles will follow the route illustrated in Figure 4-1.

The results indicate that the intersection operates well within capacity, at LOS A-B on all approaches. It is, however, recommended that the intersection be re-marked with the east-west road (Roads 27 and 26) under stop control.

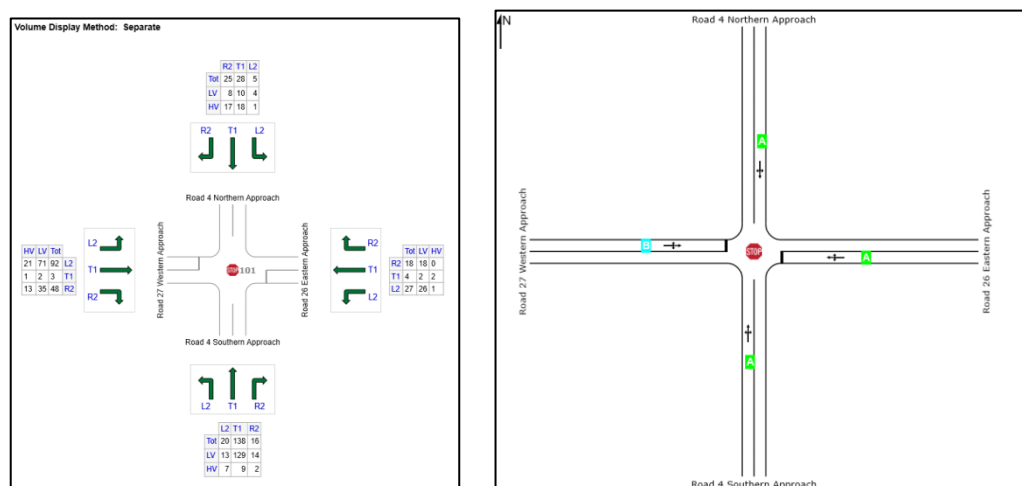

Figure 4-5 SIDRA Intersection Evaluation for Road4/Road 26 Intersection

A geometric assessment of the following intersections is required to determine whether the turning circle of the side-tipper trucks can be accommodated:

- Limestone truck movements:
 - Gate 4/D1675
 - Road 4/Road 27
 - Road 27/Road 28
 - Turning into Road 28 towards proposed staging area
- Gypsum truck movements:
 - Gate 4/D1675
 - Road 3 Ring Road West/Road 28
 - Road 28/Road 27
 - Road 27/Road 4
- WWTP truck movements
 - Gate 4/D1675
 - Road 3 Ring Road West/Road 7

No sight distance problems were observed on the roads or intersections described above and there are no tight bends in the road network under consideration.

4.3.3 Access to the Gypsum Off-take Facility

Access to the gypsum off-take facility is via Road 3 Ring Road West. The geometric design accommodates the turning circles required for the side-tipper trucks that will remove the gypsum. The design allows for sufficient manoeuvrability at the facility and accommodates all potential turning movements, as shown in Figure 4-6. The design also allows for the staging of 7 vehicles during downtime of the facility or a delay in operations at the conveyor belt system.

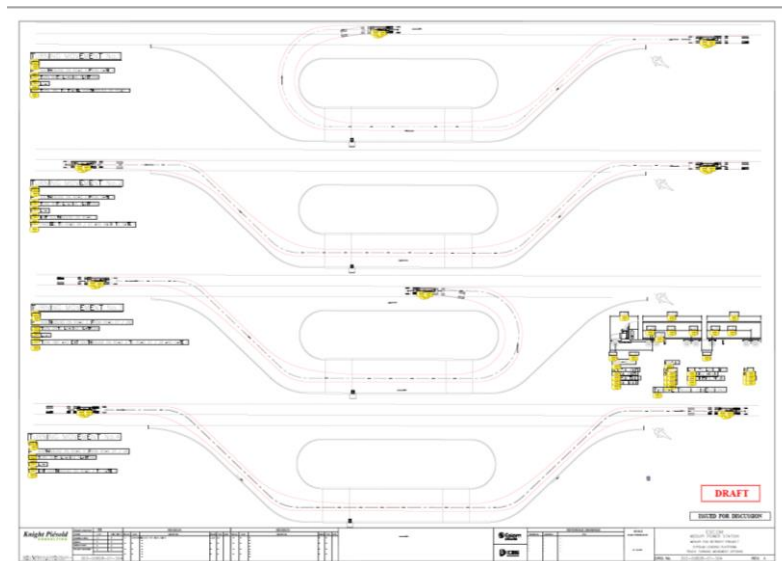

Figure 4-6 Design of access roads to Gypsum Off-take facility

The above access facility has been designed to accommodate the gypsum trucks arriving from the south or the north. All potential routes, that have been geometrically reviewed, to the off-take facility are shown in Figure 4-7.

Should the rail siding be implemented, Road 28 will be cut-off and access will revert to Road 3

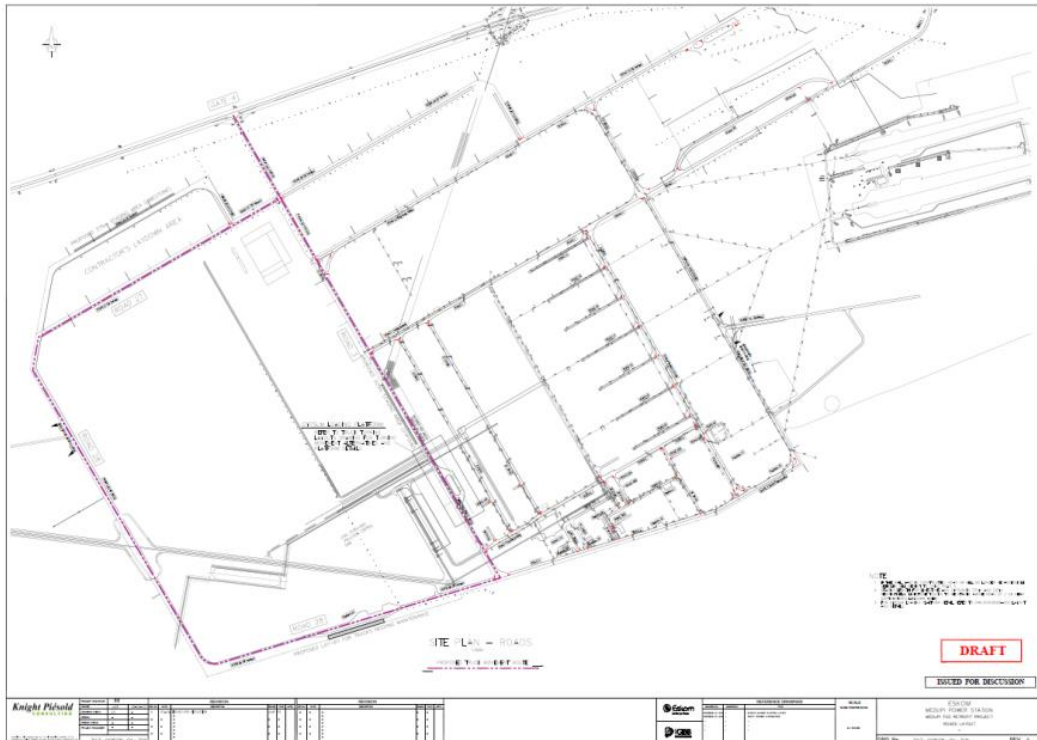

Figure 4-7 Truck routes to/from the FGD Off-take facility

4.3.4 Road Pavement Condition

Roads must be regularly maintained so that they do not develop bumps, ruts or potholes which may result in drivers losing control of their vehicles. Roads must be well drained to prevent muddy conditions which can seriously affect the manoeuvrability and braking potential of the plant and trucks using the road. Edge protection must be provided or maintained to prevent trucks from being driven over an unprotected edge. Kerbing must be provided at all staging areas to allow vehicles to safely climb the kerb when parking.

4.3.5 Signage

A clear and concise signage scheme should be implemented in the vicinity of the limestone stockpile and gypsum off-take facility and along Road 4 and Road 3 Ring Road West.

The speed limit should be signed at 40km/hr.

If required, the following recommendations are made for the erection of additional SABS Symbolic Signs SANS 1186-1:2008 (Edition 3.5), shown in Figure 4-8:

- Thoroughfare for pedestrians prohibited – there should be no loitering or unwanted persons in the vicinity of the gypsum off-take area. This can be coupled with a text sign that reads “No entry to unauthorised persons”;
- Carrying of firearms prohibited;

- Alcohol prohibited;
- Speed limit signs as warranted.

These signs should also be added to the staging area.

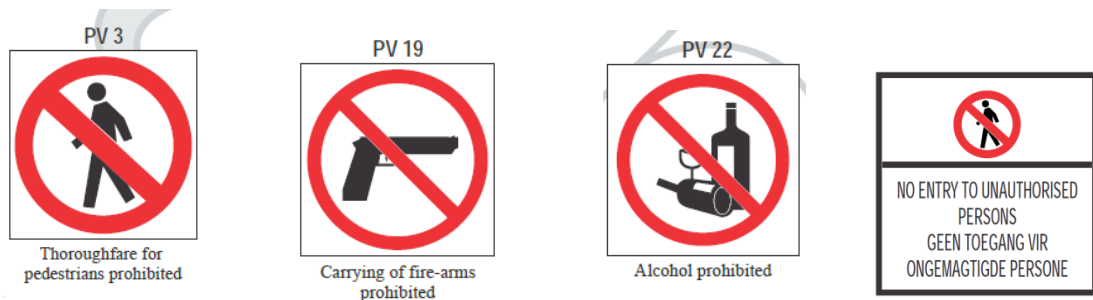

Figure 4-8 SABS Symbolic Signs

A signage audit is required before prescribing additional signage, including the number and position of the new signs.

In order to ensure that existing signs are clearly visible they should be cleaned on a regular basis. All signs should be cleaned at least once a week, should they be susceptible to coal dust from the emergency coal stockpile.

4.3.6 Non-motorised Transport

The following should apply to pedestrian activity at the FGD and Limestone Stockpile operational areas:

- Pedestrian activity should be limited to Eskom marshals/employees that direct the limestone and gypsum truck movements;
- All other pedestrian activity should wherever possible be restricted, particularly in hours of darkness;
- For certain operations “no entry” zones should be identified and clearly marked by signs, fencing, cones etc.;
- Employees must not enter operational areas as a pedestrian unless authorised to do so;
- Where practicable, pedestrian routes or zones should be established and designated with suitable signs, barriers, road markings etc. particularly in the areas where the trucks are operating or manoeuvring or parking. These areas should be more clearly defined and appropriate signage chosen during the Detailed Design Stage.

4.3.7 Traffic Calming

If trucks do not obey the speed limit on the internal road network, then certain traffic calming measures need to be considered. Due to the load and design of the trucks, speed humps are not recommended. Enforcement of the speed limit through site marshals, and increased signage is instead advised.

4.3.8 Lighting

The gypsum and limestone trucks operate over a 12 hour day, which could be exceeded if spill-over queues need to be processed after hours at the gypsum and limestone sites. Adequate lighting is therefore extremely important at all access points, including the weighbridge area.

Areas that have high pedestrian activity should have pedestrian-scale street lighting on all side walk areas. These are usually mounted 4m above the sidewalk.

4.4 Compliance with Occupational Health and Safety

All truck drivers should undergo an induction process to comply with Eskom's mandatory Safety, Health and Environment Quality (SHEQ) Policy before being allowed onto site. In addition to this, Eskom should prepare a comprehensive code of good practise or a Driver Code of Conduct that all drivers need to comply with. The Driver Code of Conduct should highlight precautions that need to be taken when operating heavy vehicles on the site, some of which should include:

- No unauthorised personnel be allowed on the site;
- Speed limit of 20km/h. to be followed;
- No overtaking is permitted, unless absolutely necessary and only when an operator of the vehicle in front indicates by a show of hand that the driver may pass;
- Reverse alarm is required on all vehicles and machinery;
- No driver or operator is allowed to get out of vehicle/machinery while waiting to offload/load except in an emergency;
- Driver/Operator may only get out of vehicle/machinery when the vehicle/machinery is well parked in a designated place;
- No use of cell phones is allowed at the site.

4.5 Impact strategies/Contingency Plans

The following risks highlighted in Table 4-3 below have been identified along with proposed mitigation measures:

Table 4-3 Risks and mitigation measures

No.	Risk	Mitigation
1	The limestone and gypsum trucks do not arrive in a predictable manner as forecast and the power station cannot schedule their activities for timely operations.	The despatch staff at the limestone quarry and the gypsum company needs to be notified of the operational issues that result from irregular departures and corrected as soon as possible.
2	Workers normally work in eight hour shifts, which	Operations within the first few

	imply that there will be a shift change during the 12-hour delivery schedule of the limestone and gypsum trucks. A shift-change normally takes 30 minutes which results in subsequent down-time of the facility. Trucks, if they arrive on schedule every hour, will queue during this 30 minute period resulting in residual queues that may not be processed during the working day.	months should be monitored to determine the typical pattern of arrivals and vehicle queue formation. If necessary, the Eskom staff will need to work an additional hour to process all residual queues at the end of the day.
3	Drivers waiting in the queue to access the stockpile or conveyor system could become bored while waiting in their truck resulting in negligent behaviour i.e. leaving the truck unattended in the queue and loitering around the truck or walking about the site.	Marshals need to be present on site to enforce the rules of the Drivers Code of Conduct.
4	The stockpile or gypsum conveyor could become inoperable due to inclement weather, resulting in longer than planned for queues of limestone/gypsum trucks.	An overflow staging area should be planned along Road 28, south of the Limestone stockpile area. The road carries very low traffic volumes and trucks could park on the side of the road during an emergency. The despatch staff at the limestone quarry and gypsum company should be notified as soon as possible to stop the arrival of trucks at the plant.
5	The weighbridges undergo maintenance for a longer than planned for period.	An emergency staging area should be accommodated in the area between the security gate and the weighbridge.

4.6 Review of the TMP

The effectiveness and proper implementation of the TMP should be reviewed by Eskom officials every 12 months or sooner if necessary. The review should be undertaken by the management team and comprise:

- Review the results of corrective measures that were enforced;
- Review of any incidents reported, the reason for the incident occurring and whether it was originally identified and mitigated in the TMP;
- Review of the operation of the gypsum and limestone areas.

It is recommended that continual improvement of the TMP be undertaken. This could be achieved through the regular evaluation of the performance of gypsum/limestone haulage and dumping operations within the plant. The continual improvement process will:

- Review the adequacy of this plan, at least annually;
- Consider any recent developments in the haulage and stockpiling of limestone and gypsum and how this impacts operations;
- Identify areas of opportunity for the improvement of operations;
- Determine the root causes of non-conformances or incidents;
- Develop and implement a plan of corrective and preventative action to address non-conformances or incidents;
- Verify the effectiveness of the corrective and preventative actions.

The outcomes of all reviews and incidents should be documented and added to the TMP.

5 FURTHER INFORMATION REQUIRED

It should be noted that the TMP will be updated with the following information, if it is available:

- Existing borrow pits for material close to site;
- Number and arrival/departure profile of construction vehicles to the site;
- Timeframe for construction of the security features at Gate 4;
- Weighbridge location and operation and timeframe for construction.
- Manuals developed by Eskom on safety procedures for Contractors, workers, drivers and all other site staff.

6 CONCLUSIONS AND RECOMMENDATIONS

The following **conclusions** are drawn:

- 1) During the construction of the TOR-related FGD infrastructure an estimated total of 10 construction trips will be added to the road network during the peak hour and a total of 31 trips during the day. Construction related traffic will utilise Afguns Road as opposed to travelling through the town of Lephalale.
- 2) The following improvements to the road network during the construction phase is proposed:
 - a. **Nelson Mandela Drive/D1675 I/S:** The intersection is manned by a pointsman during the peak hour. Since the construction activity adds only an additional loading of 10veh/hr to this intersection, it is recommended that the I/S continue to be controlled by a pointsman during the construction period;
 - b. **Afguns Road/D1675 I/S:** It is recommended that the road markings be changed such that Afguns Road becomes stop controlled and D1675 has free-flow conditions (*to be confirmed by a site visit that D1675 is currently under stop control*).
- 3) A total of 15 limestone and 9 gypsum trucks can be expected to arrive per hour on a weekday, with a total of 24 operations-related trips added to the road network. A total of 2 trips/hr can be expected from the WWTP for the transport of sludge and salts;
- 4) The following improvements to the road network during the operational phase is proposed:
 - a. **Nelson Mandela Drive/D1675 I/S:** The TIA recommended that this intersection be upgraded and signalised, which is further endorsed by this TMP. In addition to this, a protected right turn phase from the D1675 into Nelson Mandela Drive should be provided throughout the day, to enable the safe turning movement of the interlink trucks.
 - b. **Afguns Road/D1675 I/S:** The re-striping of the stop line from D1675 to Afguns Road should be monitored and if the traffic flow improves than no further improvements to the intersection may be necessary (*to be confirmed by a site visit that D1675 is currently under stop control*).
- 5) Limestone trucks will arrive at Gate 4, be weighed at the weighbridge and proceed to the area designated for the limestone stockpile where they will off-load the material. This site will be accessed via Road 4, turning left onto Road 27 and left onto Road 28. The truck will then turnaround and proceed back to Gate 4 along the same Roads 28 and 27;
- 6) The gypsum trucks will be processed at Gate 4, weighed at the weighbridges and proceed to site via Road 4 and Road 3 Ring Road West. The road system servicing the off-take facility is designed for the truck to drive to a position under the conveyor belt, receive the gypsum and turnaround on Road 3 Ring Road West and proceed to Gate 4. Alternatively the full trucks may turn left onto Road 3 Ring Road West, right onto Road 28, right onto Road 27 and left onto Road 4 to exit at Gate 4;

- 7) The WWTP trucks will be processed at Gate 4, be weighed at the weighbridges and proceed to site via Road 4 and Road 3 Ring Road West, turning left into Road 7;
- 8) The design of the off-take road system allows for sufficient manoeuvrability at the facility and accommodates all potential turning movements to access the conveyor belt. The design also allows for the staging of 7 vehicles during downtime of the facility or a delay in operations at the conveyor belt system;
- 9) The proposed truck routes for limestone and gypsum do not overlap, except for a short section of Road 4 when they enter the site;
- 10) The total truck queue length that needs to be accommodated during the downtime is 375m for limestone trucks (along Road 28 - above Road 27) and 225m (on Road 3 opposite the off-take facility) for gypsum trucks;
- 11) During this time, the gypsum trucks stage along Road 3 Ring Road West, opposite the gypsum off-take facility. Sufficient area is available on the side of the road to accommodate 9 trucks over an hour. The limestone trucks stage above Road 27 at the current contractors lay down area;
- 12) Operations within the first few months should be monitored to determine the typical pattern of arrivals and departures and subsequent queue formation. If necessary, the Eskom staff will need to work an additional hour to process all residual queues at the end of the day.

The following **recommendations** are made:

- 1) The turning circles at the following intersections, that form part of the haulage routes around the plant, need to be reviewed to ensure the limestone, gypsum and WWTP trucks are able to negotiate the turns:
 - a. Limestone truck movements:
 - i. Gate 4/D1675
 - ii. Road 4/Road 27
 - iii. Road 27/Road 28
 - iv. Turning into Road 28 towards proposed staging area
 - b. Gypsum truck movements:
 - i. Gate 4/D1675
 - ii. Road 3 Ring Road West/Road 28
 - iii. Road 28/Road 27
 - iv. Road 27/Road 4
 - c. WWTP truck movements
 - i. Gate 4/D1675
 - ii. Road 3 Ring Road West/Road 7
- 2) All truck drivers should undergo an induction process to comply with Eskom's mandatory Safety, Health and Environment Quality (SHEQ) Policy before being allowed onto site. In addition to this, Eskom should prepare a comprehensive Code of Good Practise or a Driver Code of Conduct that all drivers need to comply with;
- 3) The following recommendations are made with regard to the weighbridge operations:

- a. Eskom confirm that 26 trucks/hr can be expected at the weighbridge, in which case the demand exceeds the capacity of the two weighbridges. It is then recommended that a third bi-directional bridge be constructed;
 - b. The TIA recommended that a traffic count at the D1675/Gate 4 be conducted to assess the impact of trucks queueing on the D1675, should the weighbridge be out of order or over-capacity. A detailed plan showing the queueing distance available between the weighbridge and the public road should be compiled, including a truck scheduling programme to confirm all truck movements at the Gate and the weighbridge;
 - c. Depending on the outcome of the above investigation, Eskom may need to create a staging area between Gate 4 and the weighbridge for overflow trucks at the weighbridge;
 - d. The removal of the tarpaulin from the gypsum trucks should also be conducted at separate stations, away from the weighbridge area. An adequate number of stations should be provided, so that the procedure does not cause delays at the weighbridge.
- 4) An overflow staging area should be planned along Road 28, south of the Limestone stockpile area. The road carries very low traffic volumes and trucks could park on the side of the road if the proposed staging areas are full;
 - 5) The despatch staff at the limestone quarry and gypsum company should be notified as soon as possible should any mechanical fault, inclement weather etc. result in downtime that would exceed an hour, to stop the arrival of trucks at the plant;
 - 6) It is recommended that continual improvement of the TMP be undertaken. This could be achieved through the regular evaluation of the performance of gypsum/limestone haulage and dumping operations within the plant. The continual improvement process will:
 - a. Review the adequacy of this plan, at least annually.
 - b. Consider any recent developments in the haulage and stockpiling of limestone and gypsum and how this impacts operations.
 - c. Identify areas of opportunity for the improvement of operations.
 - d. Determine the root causes of non-conformances or incidents.
 - e. Develop and implement a plan of corrective and preventative action to address non-conformances or incidents.
 - f. Verify the effectiveness of the corrective and preventative actions.